



CH32R

USER MANUAL

V4.0.6 2023.10



Safety Instruction

Before using the product, please read and follow the instructions of this manual carefully, and refer to relevant national and international safety regulations.

ΔAttention

Please do not disassemble or modify the Lidar privately. If you need special instructions, please consult our technical support staff.

ΔLaser Safety Level

The laser safety of this product meets the following standards:

- IEC 60825-1:2014
- 21 CFR 1040.10 and 1040.11 standards, except for the deviations (IEC 60825-1, third edition) stated in the Laser Notice No. 56 issued on May 8, 2019. Please do not look directly at the transmitting laser through magnifying devices (such as microscope, head-mounted magnifying glass, or other forms of magnifying glasses).

Eye Safety

The product design complies with Class 1 human eye safety standards. However, to maximize self-protection, please avoid looking directly at running products.



ΔSafety Warning

In any case, if the product is suspected to have malfunctioned or been damaged, please stop using it immediately to avoid injury or further product damage.

Housing

The product contains high-speed rotating parts, please do not operate unless the housing is fastened. Do not use a product with damaged housing in case of irreparable losses. To avoid product performance degradation, please do not touch the photomask with your hands.

Operation

This product is composed of metal and plastic, which contains precise circuit electronic components and optical devices. Improper operations such as high temperature, drop, puncture or squeeze may cause irreversible damage to the product.

Power Supply

Please use the connecting cable and matching connectors provided with the lidar to supply power. Using cables or adapters that are damaged or do not meet

the power supply requirements, or supply power in a humid environment may cause abnormal operation, fire, personal injury, product damage, or other property loss.

Light Interference

Some precise optical equipment may be interfered with by the laser emitted by this product, please pay attention when using it.

Vibration

Please avoid product damage caused by strong vibration. If the product's mechanical shock and vibration performance parameters are needed, please contact us for technical support.

Radio Frequency Interference

The design, manufacture and test of this product comply with relevant regulations on radiofrequency energy radiation, but the radiation from this product may still cause other electronic equipment to malfunction.

Deflagration and Other Air Conditions

Do not use the product in any area with potentially explosive air, such as areas where the air contains high concentrations of flammable chemicals, vapours or particles (like fine grains, dust or metal powder). Do not expose the product to the environment of high-concentration industrial chemicals, including near evaporating liquefied gas (like helium), so as not to impair or damage the product function.

Maintenance

Please do not disassemble the Lidar without permission. Disassembly of the product may cause its waterproof performance to fail or personal injury.

Table of Contents

1. PRODUCT PROFILE	1
1.1 OVERVIEW.....	1
1.2 MECHANISM.....	1
1.3 SPECIFICATIONS	1
1.4 MECHANICAL STRUCTURE.....	2
1.5 LIGHT SPOT	4
2. ELECTRICAL INTERFACE	5
2.1 POWER SUPPLY	5
2.2 CONNECTORS.....	6
3. GET READY	10
3.1 LIDAR CONNECTION	10
3.2 SOFTWARE PREPARATION	10
4. USAGE GUIDE	12
4.1 OPERATION UNDER WINDOWS OS	12
4.1.1 Lidar Configuration.....	12
4.1.2 Windows Client Interface.....	13
4.1.3 Operation Procedure.....	15
4.1.4 Point Cloud Data Parsing.....	16
4.1.5 Parameter Config Example of Lidar Network Communication Mode	16
4.1.6 Note	18
4.2 ROS DRIVER OPERATION UNDER LINUX OS	21
4.2.1 Hardware Connection and Test.....	21
4.2.2 Software Operation Example.....	22
5. COMMUNICATION PROTOCOL	24
5.1 MSOP PROTOCOL.....	24
5.1.1 Format	24
5.1.2 Data Package Parameter Description	26
5.2 DIFOP PROTOCOL	28
5.3 UCWP PROTOCOL.....	30
5.3.1 Configuration Parameters and Status Description	31
5.3.2 Configuration Package Example	32
6. TIME SYNCHRONIZATION	34
6.1 GPS SYNCHRONIZATION.....	34
6.2 EXTERNAL SYNCHRONIZATION.....	35
6.3 GPTP SYNCHRONIZATION.....	36
6.4 LIDAR INTERNAL TIMING	36

7. ANGLE AND COORDINATE CALCULATION.....	38
7.1 VERTICAL ANGLE.....	38
7.2 HORIZONTAL ANGLE.....	38
7.2.1 Horizontal Angle Calculation of Single Echo Mode.....	38
7.2.2 Horizontal Angle Calculation of Dual Echo Mode	39
7.3 CARTESIAN COORDINATE REPRESENTATION	41
7.4 JUDGMENT OF ONE FRAME OF DATA.....	42
8. ACCURATE TIME CALCULATION	43
8.1 CALCULATION OF DATA PACKET END TIME	43
8.2 ACCURATE TIME CALCULATION OF CHANNEL DATA.....	43
8.2.1 End Time of Data Block	43
8.2.2 Calculate the Accurate Time of Channel Data	44
APPENDIX A. MAINTENANCE.....	46
APPENDIX B. POWER SUPPLY REQUIREMENTS.....	47

1. Product Profile

1.1 Overview

The CH32R lidar realizes 360° three-dimensional high-speed scanning with 32 dense laser beams. It reaches a detection distance of up to 120 m, measurement accuracy of ±3 cm, and a minimum vertical angular resolution of 2.61°. This lidar sensor is widely used in unmanned driving, automotive ADAS, intelligent transportation, service robot, logistics, surveying and mapping, security, industry, ports and other fields.

1.2 Mechanism

The CH32R mechanical lidar adopts the Time of Flight method. The lidar starts timing (t_1) when the laser pulses are sent out. And when the laser encounters the target object and the light returns to the sensor unit, the receiving end stops timing (t_2).

$$\text{Distance} = \text{Speed of Light} * (t_2 - t_1) / 2$$

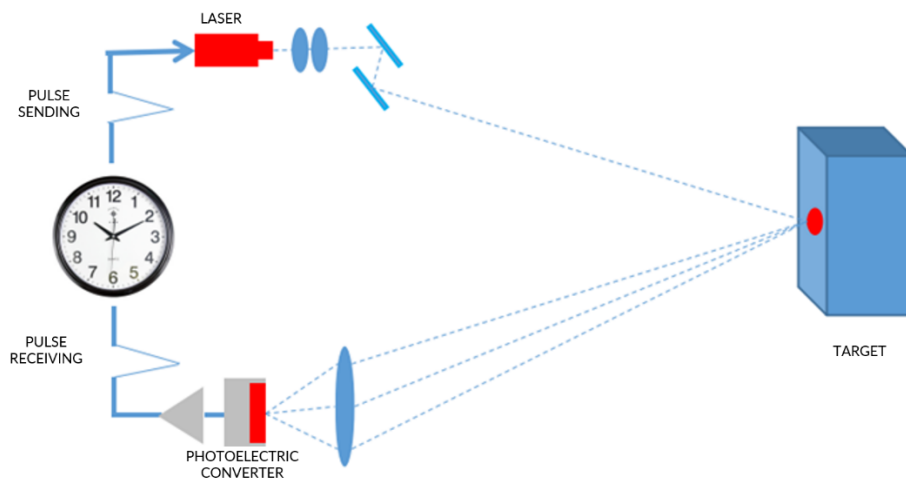

Figure 1.1 Time of Flight

1.3 Specifications

Table 1.1 Specifications of CH32R

Model	CH32R
Detection Method	ToF
Wavelength	905 nm
Laser Class	Class 1 (eye-safe)
Channels	32

Max. Detection Range	30 m (@10% reflectivity) 120 m (@70% reflectivity)	
Range Accuracy	±3 cm	
Range Precision	±1 cm	
Data Point Generating Rate (Single Echo Mode)	640,000 pts/sec	
Data Point Generating Rate (Dual Echo Mode)	1,280,000 pts/sec	
FOV	Vertical	2.487°~89.105°
	Horizontal	360°
Angular Resolution	Vertical	2.61° (minimum)
	Horizontal	5 Hz: 0.09° / 10 Hz: 0.18° / 20 Hz: 0.36°
Scanning Rate	5 Hz / 10 Hz / 20 Hz	
Communication Interface	Ethernet / PPS	
Clock Source	GPS, gPTP	
Operating Voltage	+12 V~+32 VDC	
Operating Power	12 W (Typical*); 25 W (Max)	
Divergence Angle	Fast Axis: 5.7 mrad; Slow Axis: 8.7 mrad	
Operating Temperature	-20°C~+60°C	
Storage Temperature	-40°C~+85°C	
Shock Test	500 m/sec ² , lasting for 11 ms	
Vibration Test	5 Hz~2000 Hz, 3G rms	
IP Grade	IP67	
Dimensions	Φ 100 *110 mm	
Weight	1000 g (Standard Edition)	

*Typical operating power refers to work at room temperature; the maximum operating power in special scenarios (such as low temperature start-up) is lower than 25 W.

1.4 Mechanical Structure

The CH32R lidar is equipped with 32 pairs of laser transmitter and receiver modules. Its motor is driven at a rotation speed of 5 Hz/10 Hz/20 Hz to cover a 360° scan range.

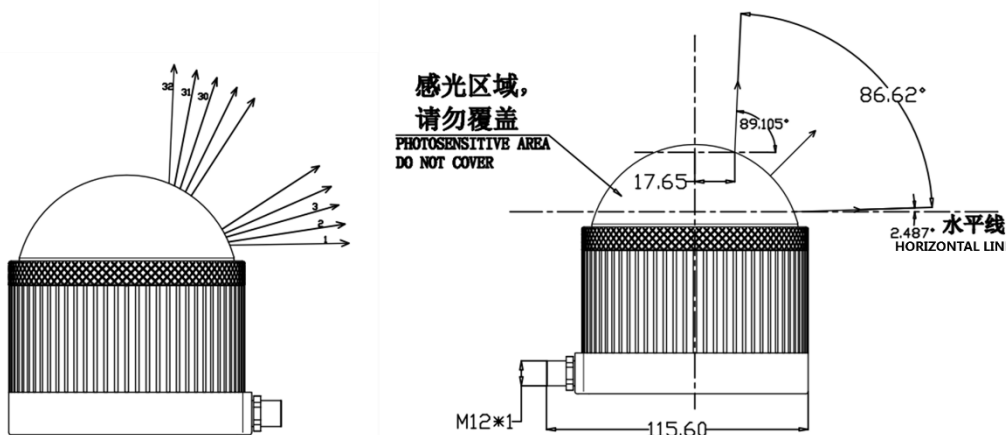

Figure 1.2 Laser Beam Distribution

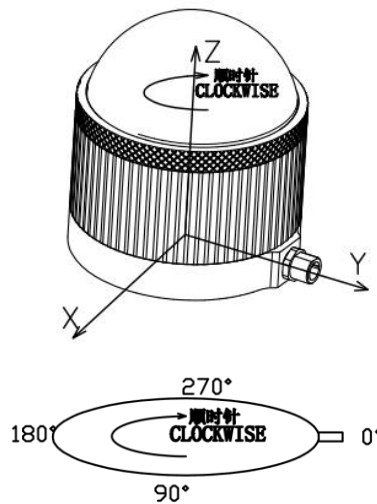

Figure 1.3 Coordinates & Scanning Direction

Note: As shown above, the cable connector of the lidar marks its zero-angle position. (It can be changed to the opposite of the cable connector in the Windows Client software.) When the laser beams pass through the position of the cable connector, the azimuth angle of the corresponding data block in the output UDP packet is 0°.

The vertical FOV of CH32R ranges from +2.487° to +89.105°, and its optical centre is at 23.7 mm of the central axis. See the figure below.

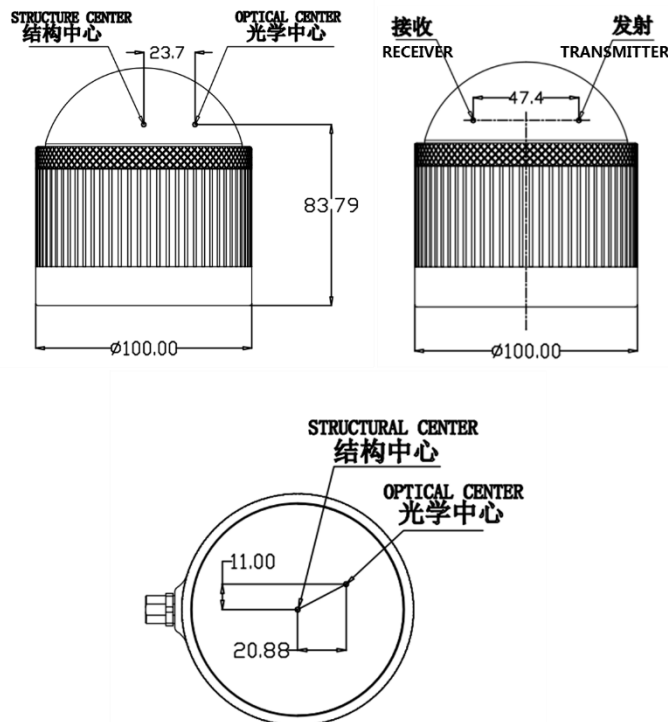

Figure 1.4 CH32R Mechanical Drawing (unit: mm)

Note: Each channel will have an inevitable deviation in the vertical direction. You can refer to the calibration file corresponding to the lidar for calibration. See the Communication Protocol for details.

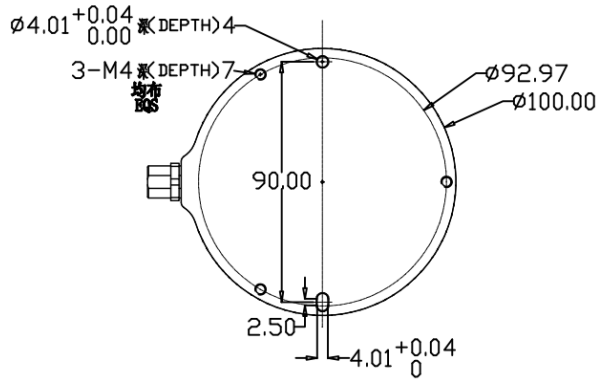

Figure 1.5 CH32R Lidar Base (unit: mm)

Note: Excessive temperatures have an impact on the life of the lidar. Please ensure that the lidar is at the correct operating temperature. If the operating temperature exceeds 38°C or if the lidar is exposed to the sun for a long period of time, it is important to use it with a heat sink. You can contact us for cooling solutions.

1.5 Light Spot

The light spot of CH32R lidar is a vertical oval. Its vertical divergence angle is 8.7 mrad, and the horizontal divergence angle is 5.7 mrad. The spot size at any distance can be calculated by multiplying the divergence angle by the distance.

For example, the calculation of a spot at 10 m is as follows:

Vertical direction at 10 m: $10 * 8.7 * 10^{-3} = 87$ mm

Horizontal direction at 10 m: $10 * 5.7 * 10^{-3} = 57$ mm

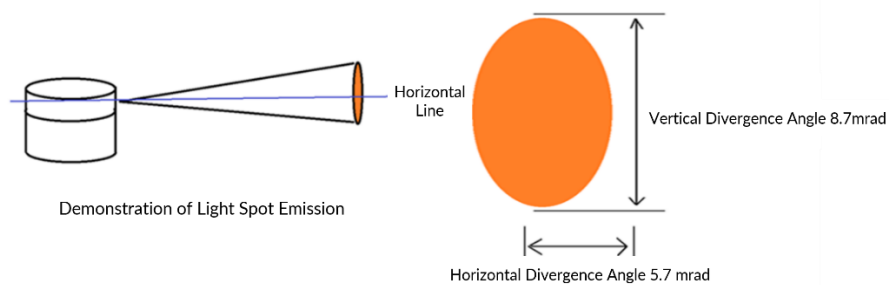

Figure 1.6 Light Spot Demonstration

2. Electrical Interface

2.1 Power Supply

This lidar's power input range is 9 V~36 VDC. If other DC power supply is adopted, the recommended output voltage is 12 V, 19 V, 24 V or 32 VDC. The output power should be ≥ 30 W (the lidar requires a large instantaneous current to start, and a small starting current may cause its failure to start normally). The output ripple noise should be < 100 mV (Vp-p) and output voltage accuracy $< 5\%$.

The higher the power supply voltage and the stronger the discharge capacity, the more severe the impact on the lidar. Before mounting the lidar, please contact our technical support personnel for power supply environment evaluation to avoid damage.

The length of the lidar power supply cable is 5~10 m, and the power supply voltage needs to be over 19 V. If the power cable is more than 10 m long, then it is recommended to use a 220 VAC adapter to supply power (DC long-distance power supply is not recommended). This information is based on experience and is for reference only. For specific power supply environment requirements, please refer to Appendix B: Power Supply Requirements for details.

Table 2.1 Electrical Parameter

Item	Min.	Recommended	Max.	Note
Supply Voltage	9 V	12 V/19 V /24 V/32 V	36 V	If the power supply voltage is not within this range, it may cause inaccurate ranging or irreversible damage. It is not allowed to use a power supply lower than 9 V or higher than 32 V for long-term power supply. The output power of the power supply should be at least 25 W.
Ripple	-	-	100 mV	The smaller the ripple, the better. Too much ripple will cause irreversible damage to the hardware.
Working Current	-	900 mA	1500 mA	12 V power supply at 10 Hz recommended. When scanning at 20 Hz, the lidar power consumption will also be higher than the recommended value.
GPS PPS	-13 V		13 V	The period is 1 second, the recommended pulse width is more than 1 ms.
GPS REC	-13 V		13 V	RS232 level, baud rate 9600 bps, compatible with TTL and RS232 level.

2.2 Connectors

Male connector on the lidar base

There is an 8-pin male connector on the side of the CH32R lidar base, and the wires can be led out by using an extension cable with a female socket, an adapter cable or an interface box. The cable connector model on the side of the CH32R lidar base is L102-M12-Z08A118. You can use an extension cable with a female connector or an adapter cable to lead out the wires to achieve system power supply and data communication. The lidar supports GPS timing function, and the cable connector is shown in Figure 2.1 below.

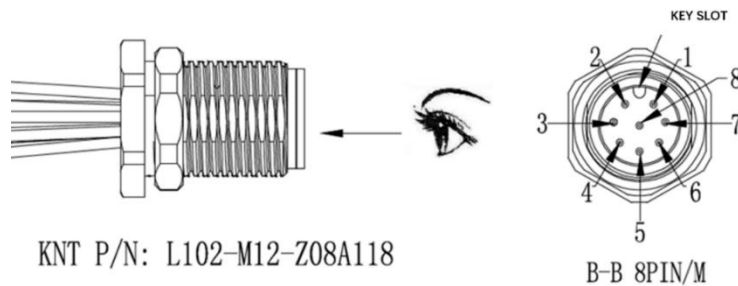

Figure 2.1 Cable Connector on the Lidar Base

The definition of the 8-pin male connector is shown in the table below.

Table 2.2 Pin Definition of the 8-pin male connector

Pin	Definition	Level	Description
1	VIN	9~36 V	Power+
2	TD_P	-1~1 V	Ethernet data flow: lidar→external devices
3	TD_N	-1~1 V	Ethernet data flow: lidar→external devices
4	RD_P	-1~1 V	Ethernet data flow: external devices→lidar
5	RD_N	-1~1 V	Ethernet data flow: external devices→lidar
6	GPS_PPS	-13~13 V	GPS Sync Pulse/External Sync Pulse
7	GPS_Rec	-13~13 V	GPS latitude & longitude, hour/minute/second
8	GND	0V	Power-

There are three kinds of cables for you to choose to connect the lidar, see the details below.

(1) Adapter Cable (Default)

In order to facilitate wiring, LeiShen Intelligent provides an adapter cable. The cable and its wiring definition are as follows:

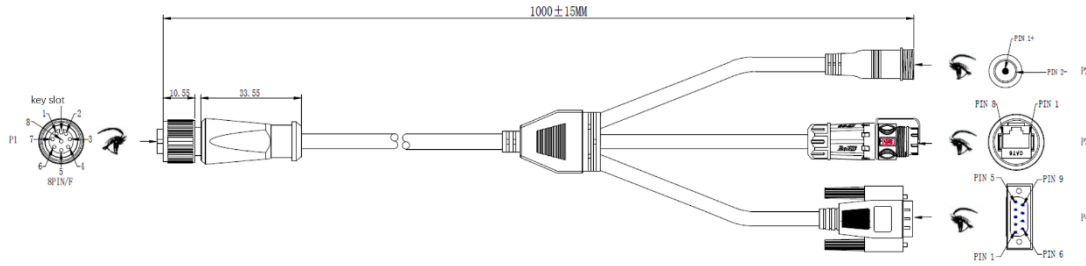

Figure 2.2 Adapter Cable

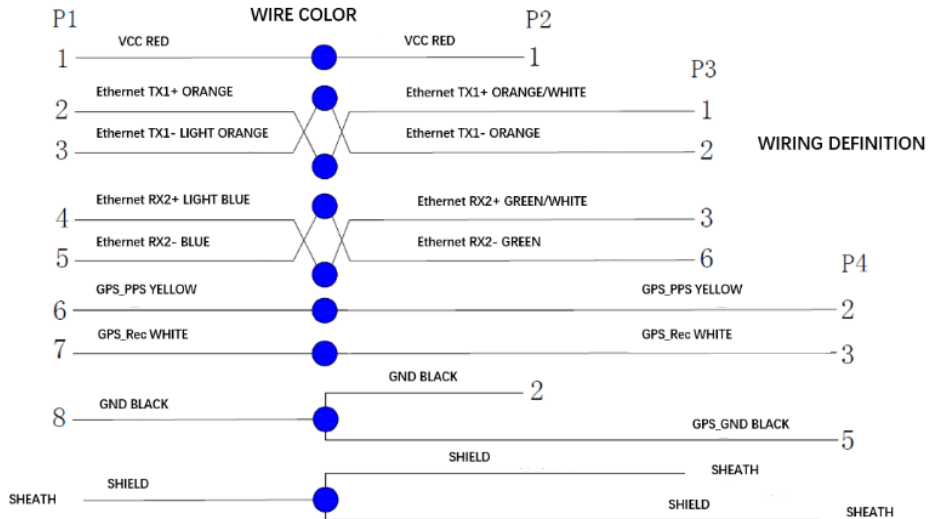

Figure 2.3 Wiring Definition of the Adapter Cable

Table 2.3 Connectors Description of the Adapter Cable

S/N	Connector	Note
P1	Lidar Connecting Port	Aviation terminal, whose wiring definition is the same as the extension cable, model: L102-M12-T08A02M
P2	Power Port	Connect external power supply, connector specification: DC5.5*2.1
P3	Standard Ethernet Port	Fast Ethernet, standard RJ45 connector with standard 568B wiring scheme
P4	Timing Synchronization Port	DB-9 connector, REC baud rate: 9600 bps; the recommended PPS pulse width is to exceed 1ms, period: 1s; PPS and REC signals are compatible with both TTL and RS232 levels

Note: Pin 2 of P2 and pin 5 of P4 connect to the same ground wire.

Table 2.4 Wire Definition of P1

S/N	Wire Color & Size	Definition	Description
1	Red (20AWG)	VCC	Power+
2	Orange (24AWG)	Ethernet TX1+	-
3	Light Orange (24AWG)	Ethernet TX1-	-

4	Light Blue (24AWG)	Ethernet RX2+	-
5	Blue (24AWG)	Ethernet RX2-	-
6	Yellow (20AWG)	GPS_PPS	GPS Sync Pulse/External Sync Pulse
7	White (20AWG)	GPS_Rec	GPS latitude & longitude, hour/minute/second
8	Black (20AWG)	GND	Power-

(2) Extension Cable (Optional)

If an extension cable is needed, LeiShen Intelligent can provide an optional customized extension cable. When plugging and unplugging the cable, be careful not to plug it with power on, otherwise it will cause irreversible damage. To plug the cable, align with the key position and insert it into the connector, and then rotate the cover to fix it to ensure good contact and not loose. To unplug it, first rotate the cover, loosen it and then pull it out. Do not use brute force to avoid terminal deformation or even short circuit. If the connector is damaged, please contact technical support in time to replace it. The connector terminal model of the extension cable is: L102-M12-T08A02M.

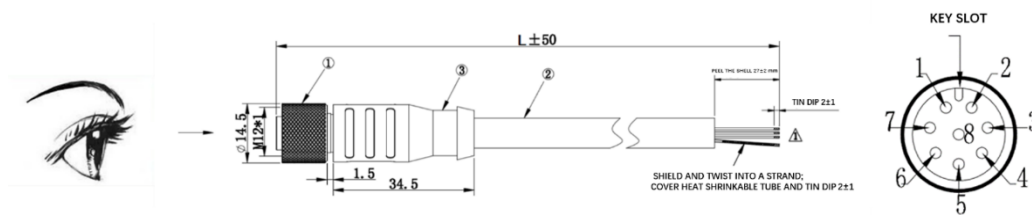

Figure 2.4 CH32R Lidar Extension Cable (unit: mm)

Table 2.5 Wire Definition of the Lidar Extension Cable

S/N	Wire Color & Size	Definition	Description
1	Red (20AWG)	VCC	Power+
2	Light Blue (24AWG)	TD_P	Ethernet TX+
3	Blue (24AWG)	TD_N	Ethernet TX-
4	Light Orange (24AWG)	RD_P	Ethernet RX+
5	Orange (24AWG)	RD_N	Ethernet RX-
6	Yellow (20AWG)	GPS_PPS	GPS Sync Pulse/External Sync Pulse
7	White (20AWG)	GPS_Rec	GPS latitude & longitude, hour/minute/second
8	Black (20AWG)	GND	Power-

(3) Interface Box (Optional)

To facilitate the testing and connection of connectors, the CH32R lidar can also be equipped with an interface box, which is not a necessary accessory for lidar operation. On the interface box, there is a Φ5.5*2.1 mm DC socket, an indicator light, an RJ45 network port and a 6-pin GPS port, as shown in the figure below.

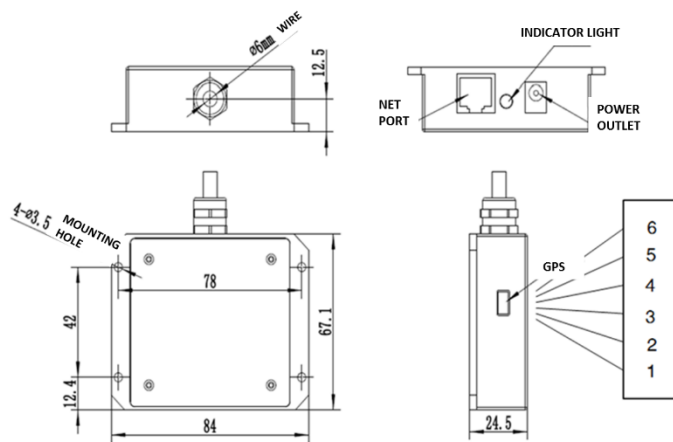

Figure 2.5 Interface Box

The GPS interface socket specification of the interface box is SM06B-SRSS-TB of JST, and the recommended plug interface for the external GPS module is SHR-06V-S-B of JST. The interface definitions are as follows:

Table 2.6 GPS Interface Definition

PIN	Function Definition	I/O	Requirement
1	PPS Sync Signal	I	TTL level ranges from 3.3 V to 12 V, its period is 1 second, and the recommended pulse width is over 1 ms
2	GPS Power Supply 5 V	O	No hot plug or unplug
3	GPS_GND	O	Good contact
4	GPS (latitude/longitude, hour/ minute/second)	I	REC baud rate is 9600 bps, compatible with TTL and RS232 levels
5	GPS_GND	O	Good contact
6	NC	-	-

If you need multiple lidars to build maps at the same time, LeiShen Intelligent provides a GPS synchronization board to solve the problem of insufficient timing signal driving capability of your controller. This item is optional, please contact our technical support for information.

Note: The temperature resistance of the wire is -40°C~105°C, and cold-resistant materials are used.

3. Get Ready

3.1 Lidar Connection

To get ready for the lidar operation, please connect the lidar to the computer as shown in figure 3.1.



Figure 3.1 Connecting Lidar and Computer

Note: Under any circumstances, it is forbidden to plug and unplug the aviation terminal with power on. When plugging and unplugging the GPS module from the GPS port of the interface box, or connecting or disconnecting the signal from the GPS pin of the cable, please make sure that the lidar is powered off.

3.2 Software Preparation

This lidar can be operated under both Windows operating system and Linux operating system. Software needed is as follows:

Wireshark: to capture the ARP (Address Resolution Protocol) packets.

Note: Wireshark is a third-party software, and you may need to download it by yourself. LeiShen Intelligent bears no responsibility for any copyright and commercial disputes caused by users' use of the software.

To view the point cloud data generated by the lidar, you can either use the **Windows Client** or the **ROS Drive Program**.

Windows Client (optional): a host computer software to view point cloud images under Windows operating system, which is also referred to as "point cloud

display software”. Simple functions like parameter configuration, lidar test and fault detection can be realized through the client, too.

- Software Acquisition

This Windows Client has been pre-stored in the USB flash drive provided along with the lidar. It can also be obtained from the sales or technical support personnel. No installation is required to the Client.

- Operating Environment

This software can only run under the Windows x64 operating system at present. The computer configuration requirements for installing the software are: CPU: Intel(R) Core (TM) i5 or higher; Graphics Card: NVIDIA GeForce GTX750 or higher achieves the best effect, otherwise the display of the point cloud may be affected. And the computer graphics card must support OpenGL 2 or higher graphics acceleration to display the point cloud normally.

- Supplemental Software

To use the Windows Client, it is necessary to install the **WinPcap** third-party library. This software has also been pre-stored in the USB flash drive provided with the lidar.

To install the WinPcap software, please follow the following steps:

Step 1. Insert the USB driver into the computer port and open it.

Step 2. Find the WinPcap installation file and double-click it to initiate the installation.

Step 3. Click “next” to enter the installation path selection interface.

Step 4. Click “next” to enter the installation interface.

Step 5. Click the “install” button, and wait for the installation to be completed.

ROS Driver Program (optional): to view the point cloud data under Linux operating system. This program has been pre-stored in the USB flash drive provided with the lidar. It can also be obtained from the sales or technical support personnel. No installation is required.

4. Usage Guide

This part states the operation instructions of the LSCH32R Windows Client and ROS driver presented by the LeiShen Intelligent System Co. Ltd.

4.1 Operation Under Windows OS

4.1.1 Lidar Configuration

The default IP address and port number of the lidar network are as follows:

Table 4.1 Default Lidar Network Configuration

	IP Address	UDP Device Package Port Number	UDP Data Package Port Number
Lidar	192.168.1.200	2368 (Fixed)	2369 (Fixed)
Computer	192.168.1.102	2369	2368

Note:

The lidar IP (local IP) and the computer IP (destination IP) cannot be set to the same, otherwise the lidar will not work normally.

In the multicast mode, no two destination ports should be set to the same port number.

The lidar IP range are **forbidden** to be set to

- 1) Class D IP address (multicast address: i.e. 224.0.0.0~ 239.255.255.255)
- 2) Class E IP address (reserved address: i.e. 240.0.0.0~ 255.255.255.254)
- 3) Broadcast address (i.e. 255.255.255.255 and xx.x.255 for each network segment)
- 4) Special class IP address (0.x.xx and 127.xxx)

The lidar destination IP are **forbidden** to be set to

- 1) Class E IP address (i.e. 240.0.0.0 to 255.255.255.254)
- 2) Special class address (0.x.xx and 127.x.x.x)

When connecting to the lidar, if the computer IP and the lidar IP are in different network segments, the gateway is needed to be set; if they are in the same network segment, only different IPs are needed to be set, for example: 192.168.1.x, and the subnet mask is 255.255.255.0. If you need to find the Ethernet configuration information of the lidar, please connect the lidar to the computer and use “Wireshark” to capture the ARP packet of the device for

analysis. For the feature identification of the ARP packet, see the figure below.

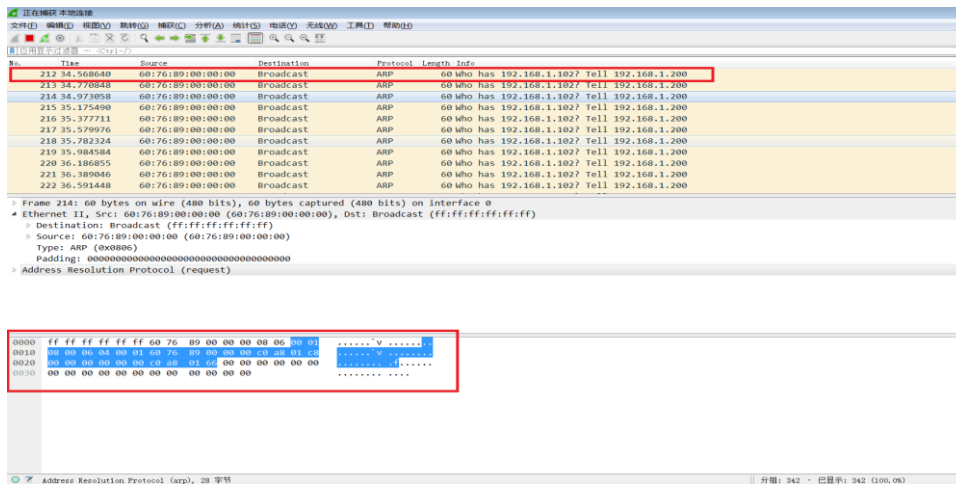

Figure 4.1 Wireshark Captures ARP Packet

4.1.2 Windows Client Interface

The software interface includes menu area, tool bar area, 3D window area, data table area, etc.

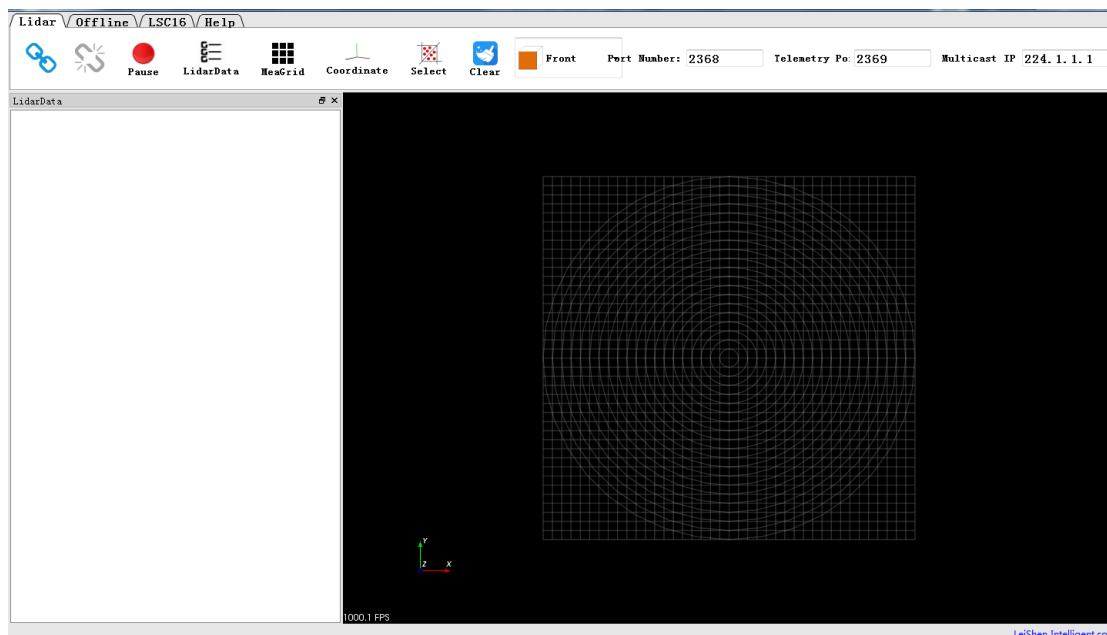

Figure 4.2 Windows Client Interface

Note: To view the software version, click “Help->About” in the toolbar.







The point cloud display interface supports the following operations:

- 1) Zoom in/out the display interface with the mouse wheel; hold the right mouse button and drag it up/down to zoom in/out.

- 2) Hold the left mouse button and drag it to adjust the angle of view;
- 3) Hold the mouse wheel and drag it to pan the display interface; or hold the shift key on the keyboard and the left mouse button to pan the interface.

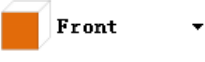
Menu button function introduction







● Lidar Menu







Button	Description
	Connect/disconnect lidar
 Clear	Clear screen
 Coordinate	Show/hide coordinate
 Front	Three-view option: set the observation angle from top, front, and left. 
 Pause	Pause point cloud image and data generating
 MeaGrid	Show/hide measurement grids

Note: Click  MeaGrid to show measurement grids if needed. There are altogether 20 circles and 40*40 grids, the radius of each two adjacent circles differs by 10 m. The difference between every two grids (horizontal or longitudinal) is 10 m. And the radius of the outermost circle is 200 m.





The grids and circles make it easy to view the position of the point cloud. The direction of the coordinate axis in the 3D display interface is consistent with the direction of the X-Y axis in the point cloud reference system.

● Offline Menu

Button	Description
 Open	Open offline data
 Record	Record and save data, valid only when lidar receives data in real time
	Skip to the beginning
	When paused, view the previous frame; When playing, rewind (click multiple times to select 2x, 3x, 1/2x, 1/4x and 1x speed) 
	Click to start playing after the point cloud file is loaded When playing, click to pause

	When paused, view the next frame; When playing, fast forward (click multiple times to select 2x, 3x, 1/2x, 1/4x and 1x speed)	   
	Skip to the end	
	Drag the progress bar or enter the frame number to skip to the specified position	

● Setup Menu

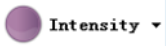
Button	Description	
	Open lidar parameter form	The upper part of the form shows the lidar configuration. The parameters include local IP, destination IP, subnet mask, gateway, local port, destination port, and motor speed setting, whether to obtain the local time, Mac address information, and device packet sending interval. The lower part shows the real-time status information. According to the DIFOP status packet sent out regularly by the lidar, the current status information is displayed, including GPS position information, satellite time information, motor speed, current lidar IP, and current lidar port number.
	Select laser channel	Vertical Angle column represents the vertical angle of the corresponding channel data and Channel column represents the data sequence number corresponding to the channel.
	Save the data in .csv format	
	Set the mode of echo	Dual echo, strongest echo, second echo
	Set the display mode of the point cloud	Intensity, laser ID, azimuth angle, etc.

4.1.3 Operation Procedure

Step 1. Set the data port number (default 2368), device package port (telemetry port in the following picture) number (default 2369), and multicast IP.

Data Port: <input type="text" value="2368"/>	Telemetry Port: <input type="text" value="2369"/>	Multicast IP: <input type="text" value="224.1.1.1"/>
--	---	--

Step 2. Click  to receive the lidar data in real time.

Step 3. The data table contains (PointID, Points_m_XYZ, adjustedtime, Azimuth, Distance, Intensity, Laser_id, timestamp).

4.1.4 Point Cloud Data Parsing

If you need to parse lidar data, please follow the steps below:

Step 1. Parse the data package to obtain the relative horizontal angle, ranging information, intensity data and timestamp information of each laser;

Step 2. Read the device package to obtain information such as the horizontal correction angle value, UTC (GPS or NTP time service) and the current configuration of the device;

Step 3. Obtain the vertical angle of each line according to the laser beam distribution;

Step 4. According to the distance measurement value, vertical angle and the calculated horizontal angle of the point cloud data, the XYZ coordinate values are obtained;

Step 5. If necessary, calculate the precise time of the point cloud data through UTC, timestamp, light-emitting time of each laser, as well as single and dual echo modes;

Step 6. Reconfigure information such as Ethernet, PPS synchronization horizontal angle, motor speed and other information as needed, and pack the configuration package protocol.

4.1.5 Parameter Config Example of Lidar Network Communication Mode

Unicast

The lidar IP address and the computer IP (computer IP in the following picture) address are in the same network segment.

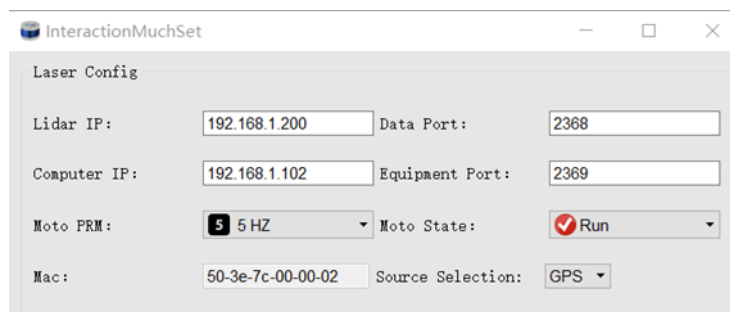

The lidar IP address and the computer IP address can be used in different network segments. When modifying, the network configurator needs to contain the lidar IP and computer IP segments.

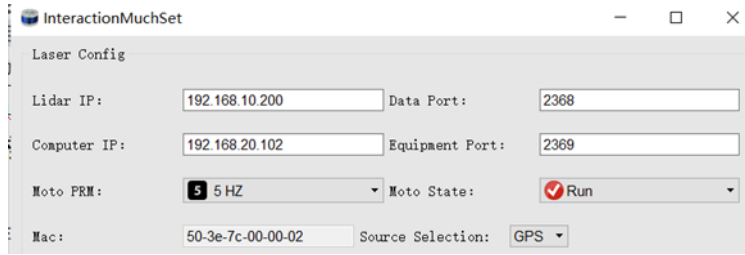

Multicast

The computer IP is the address of the multicast group. The default subnet mask is 0.0.0.0 and the default gateway is 0.0.0.0. No need to configure the subnet mask or the gateway.

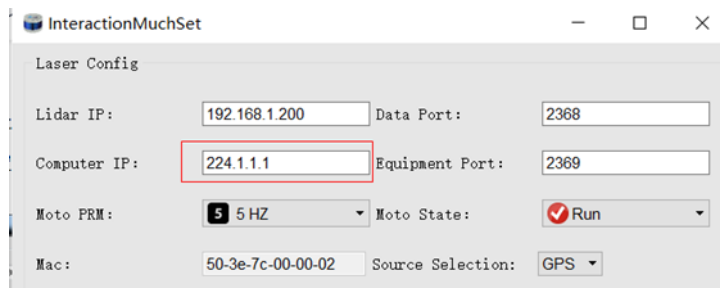

Broadcast

Under the broadcast mode, the computer IP address is the broadcast address, and the lidar IP address and the computer IP address are in the same network segment. Then the subnet mask should be configured as 255.255.255.0, and the default gateway is 0.0.0.0.

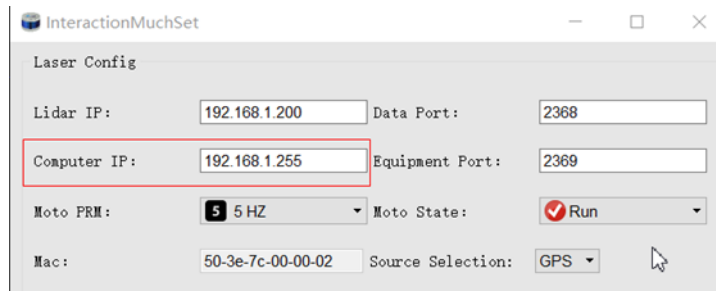

4.1.6 Note

Notice about the lidar setting and usage:

- 1) It is not possible to use Windows Client to receive data in two processes (open twice at the same time) on the same computer. The port occupancy of the PC is generally exclusive, so the other software that uses the same process or the same port number cannot work normally after a process is bound to a specified port number. When the Windows Client detects that the port is occupied, it will prompt that the communication network port configuration has failed, and automatically close the software. You need to close the software process that occupied the port, and reopen the Client to use it normally.
- 2) At the same time, since Qt is adopted in the low-level software development, please create English paths when naming files and path folders.
- 3) Since the port number of the CH32R lidar can be modified through user configuration, and the lidar sends data to the host computer through the preset destination IP and port. Therefore, when the local laptop or desktop computer and other devices are receiving data, their IP address should be the same as the destination IP, and the port bound to the local host computer program needs to be the same as the destination port number, as shown in the figure below (these are the data packet parameters captured and analyzed by Wireshark software). The data in the red boxes indicate the destination IP and port number of the lidar.

Time	Source	Destination	Protocol	Length	Info
1 0.000000	192.168.3.208	192.168.3.144	UDP	1248	2368 → 2368 Len=1206
2 0.000704	192.168.3.208	192.168.3.144	UDP	1248	2368 → 2368 Len=1206
3 0.001318	192.168.3.208	192.168.3.144	UDP	1248	2368 → 2368 Len=1206

Figure 4.3 Data Packet Parameters Captured by Wireshark Software

Please set the host computer IP according to the following steps:

Step 1. In the Control Panel -> All Control Panel Items -> Network Connections, click the "Ethernet" icon.

Step 2. Click "Properties" in the pop-up status box, and click "TCP/IPv4 protocol"

in the pop-up Ethernet properties box, as shown in the figure below.

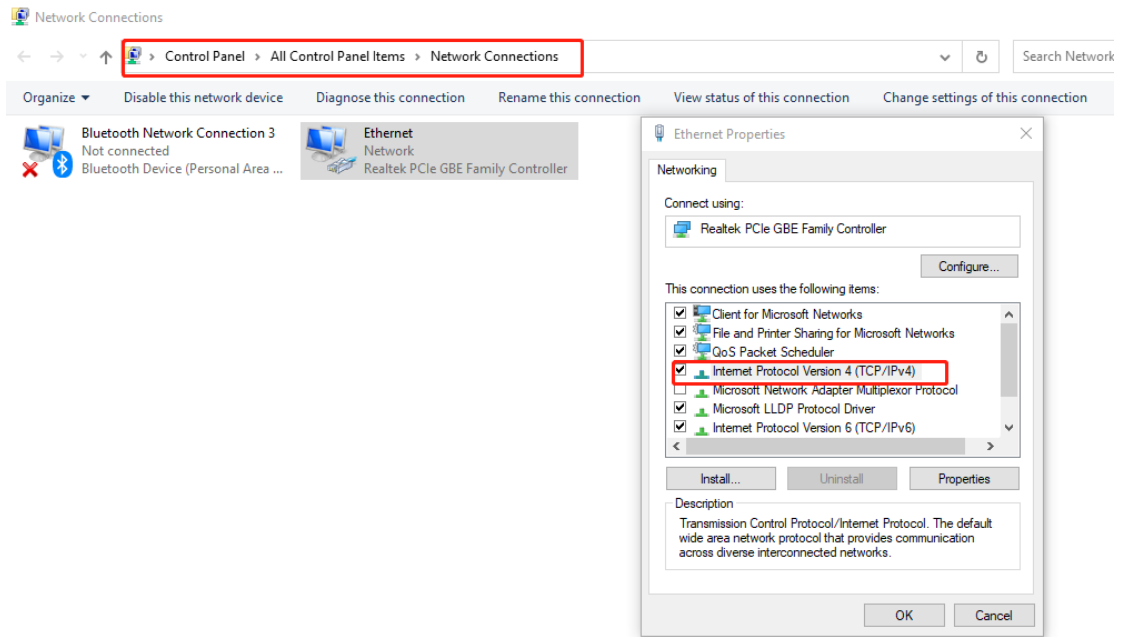

Figure 4.4 Network Connections

Step 3. In the TCP/IPv4 property settings, set the IP address to the lidar's destination IP (The default destination IP of the lidar is 192.168.1.102), and the subnet mask is set to 255.255.255.0.

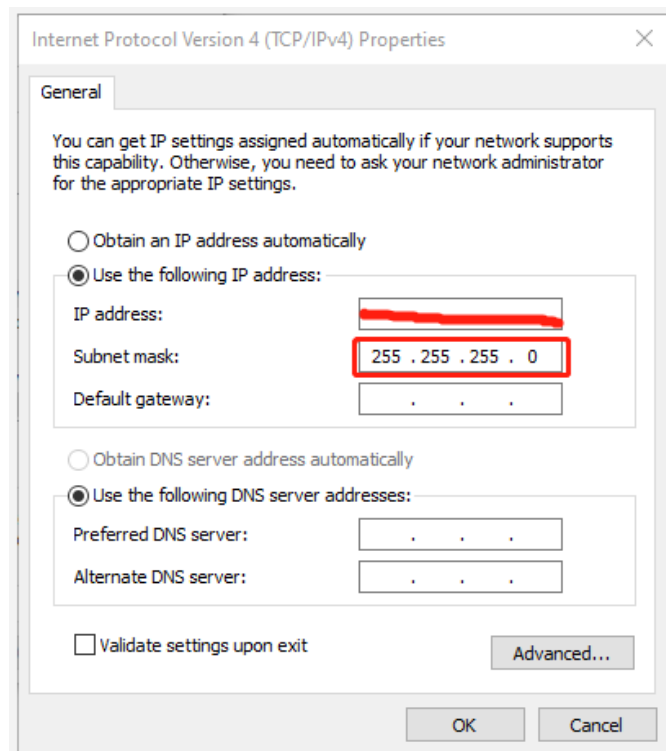

Figure 4.5 IP Address and Subnet Mask Setting

4) Since the Windows Client needs to obtain a large number of data packets through the network in a short time, it may be considered as a malicious program by the network firewall and be prohibited. Therefore, there may be situations in which the data packet has been sent to the computer by the Wireshark software, but the client cannot display it.

To address this problem, in Control Panel -> System and Security -> Windows Firewall Settings, click to allow this program to pass through Windows Firewall, setting steps are as shown in the figures below:

Step 1. In Control Panel -> System and Security -> Windows Defender Firewall, click “Allow an app or feature through the Windows Defender Firewall”.

Step 2. Browse to find the software installation path, select it and click OK.

Step 3. Tick the part marked in the red box according to the nature of your network, and click OK to see the data.

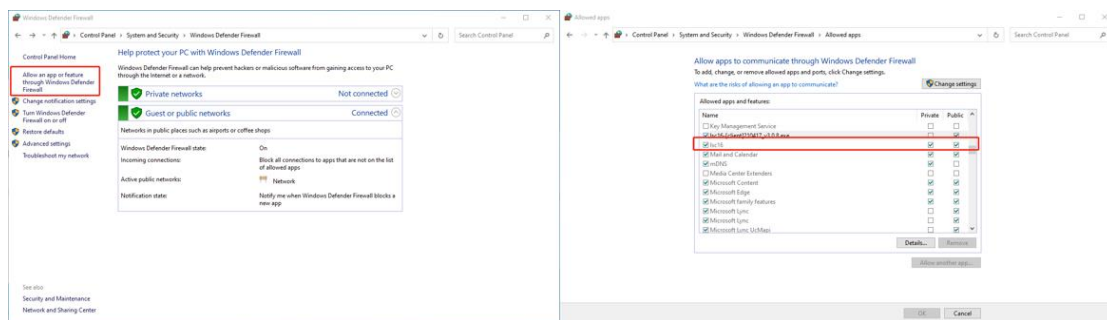

Figure 4.6 Windows Defender Firewall Setting

Computer graphics settings

When installing the Windows Client on a desktop or laptop with dual graphics cards, the default global settings of the computer operating system is to use the global settings (automatic selection: integrated graphics), which affects the display efficiency of the software. In order to ensure the use and display efficiency of the software, you need to manually set the computer graphics.

The condition of dual graphics cards can be checked in the computer configuration, and the condition of the display adapter can be seen in My Computer->Properties->Device Manager.

Take a laptop with Intel(R)HD Graphics 530 integrated graphics and NVIDIA GeForce GTX 960 discrete graphics as an example. The setting steps to manually switch the applicable graphics card of the software to high-performance discrete graphics card are as follows:

Step 1. Right-click on a blank space on the desktop to pop up a right-click menu

and select “NVIDIA Control Panel”.

Step 2. Select the “Manage 3D Settings” in the NVIDIA Control Panel interface.

Step 3. Click the “Program Settings” button in the Manage 3D Settings interface.

Step 4. Click the “Add” button on the Manage 3D Settings interface.

Step 5. Click the “Browse” button in the pop-up interface.

Step 6. Find the application file (.exe file) of the software according to its installation path in the pop-up browsing interface.

Step 7. Click “OK” to automatically return to the NVIDIA control panel, select the high-performance NVIDIA processor in the combo box of the preferred graphics processor for this program in Option -2., and click “Apply” in the lower right corner.

After the computer application is set, close the NVIDIA Control Panel to complete the setting.

4.2 ROS Driver Operation Under Linux OS

4.2.1 Hardware Connection and Test

Step 1. Connect the lidar to the internet and power supply

Step 2. Set the computer wired IP according to the destination IP of the lidar, (whether the computer wired IP is set successfully can be checked by the ifconfig command, as shown in the figure, the destination IP is 192.168.1.102)

```
ls@ls-Inspiron-15-3511:~$ ifconfig
enxf8e43b292f8c: flags=4163<UP,BROADCAST,RUNNING,MULTICAST> mtu 1500
    inet 192.168.1.102 netmask 255.255.255.0 broadcast 192.168.1.255
    inet6 fe80::898a:1bfd:a729:2f4e prefixlen 64 scopeid 0x20<link>
    ether f8:e4:3b:29:2f:8c txqueuelen 1000 (以太网)
    RX packets 254127 bytes 313581906 (313.5 MB)
    RX errors 254118 dropped 3 overruns 0 frame 254118
    TX packets 76 bytes 9406 (9.4 KB)
    TX errors 0 dropped 0 overruns 0 carrier 0 collisions 0
```

Figure 4.7 ifconfig Command Feedback

Note: The default destination IP of the lidar is 192.168.1.102, and the computer must be configured according to the actual lidar destination IP. After setting the IP for the first time, please restart the lidar.

Step 3. After the lidar is powered on and restarted, check the wired connection icon of the computer to see whether it is connected properly.

Step 4. Open the terminal: ping the lidar IP, and test whether the hardware is connected normally. If the ping is successful, then the data is received, otherwise

check the hardware connection.

Step 5. Use “sudo tcpdump -n -i eth0” (here eth0 is the name of the wired network device, see the device name of ifconfig wired connection display for details) to view the data packets sent by the lidar (as shown in the figure, there are 1206-byte data packets sent by the lidar to the destination, which means that the lidar data is sent normally).

```
leishen@robot:~$ sudo tcpdump -n -i eth0
tcpdump: verbose output suppressed, use -v or -vv for full protocol decode
listening on eth0, link-type EN10MB (Ethernet), capture size 262144 bytes
19:49:08.973111 IP 192.168.1.200.2368 > 192.168.1.102.2368: UDP, length 1206
19:49:08.973717 IP 192.168.1.200.2368 > 192.168.1.102.2368: UDP, length 1206
19:49:08.974308 IP 192.168.1.200.2368 > 192.168.1.102.2368: UDP, length 1206
19:49:08.974913 IP 192.168.1.200.2368 > 192.168.1.102.2368: UDP, length 1206
19:49:08.975517 IP 192.168.1.200.2368 > 192.168.1.102.2368: UDP, length 1206
19:49:08.976107 IP 192.168.1.200.2368 > 192.168.1.102.2368: UDP, length 1206
19:49:08.976714 IP 192.168.1.200.2368 > 192.168.1.102.2368: UDP, length 1206
19:49:08.977308 IP 192.168.1.200.2368 > 192.168.1.102.2368: UDP, length 1206
```

Figure 4.8 sudo tcpdump -n -i eth0 Command Feedback

4.2.2 Software Operation Example

Step 1. Establish a workspace and build a compilation environment

```
mkdir -p ~/leishen_ws/src
```

```
cd ~/leishen_ws
```

Note: The workspace can be named arbitrarily. For example, “leishen_ws” can be changed to any name.

Step 2. Download the Lidar ROS driver

The ROS driver can also be obtained directly from our website or customer service. Copy the obtained driver file to the newly created workspace “src”, and decompress it.

Step 3. Compile and package

```
cd ~/leishen_ws
```

```
catkin_make
```

Step 4. Run the program

```
source ~/leishen_ws /devel/setup.bash
```

```
roslaunch lslidar_c32_decoder lslidar_c32.launch -screen
```

Reopen a terminal again and execute the following command:

```
roslaunch rviz rviz
```

Note 1): If the lidar destination port and motor speed are modified, please open

“lslidar_c32.launch” to modify the configuration accordingly. The default data packet port is 2368, device packet port is 2369, IP address is 192.168.1.200.

Note 2): If timeout appears, it means that the driver has no data reception. Please check the hardware connection.

Note 3): If steps 1, 2, and 3 have been completed, next time after the “Displays Window” is reopened, start directly from Step 4.

Step 5. Display the lidar’s point cloud data

Check the point cloud data in the pop-up RVIZ window.

Step 6. Modify configuration

You can modify the configuration parameters in the launch file. For specific parameter descriptions, see the decompressed README.md document.

5. Communication Protocol

The data output and configuration of the lidar are through Fast Ethernet UDP/IP communication protocol. There are 3 UDP packet protocols, among which MOSP packet length is 1254 bytes (42 bytes Ethernet header and 1212 bytes payload). DIFOP and UCWP are 1248 bytes (42 bytes Ethernet header and 1206 bytes payload) lidar supports unicast, broadcast and multicast communication.

The communication protocols of the lidar are:

Main data Stream Output Protocol (MSOP): outputting the distance, angle, intensity and other information measured by the lidar;

Device Information Output Protocol (DIFOP): outputting the current status of lidar and accessory equipment and various configuration information;

User Configuration Write Protocol (UCWP): setting the configuration parameters of the lidar.

Table 5.1 UDP Packet Protocol

Protocol Name	Abbreviation	Function	Length	Transmission Interval
Main data Stream Output Protocol	MSOP	Outputting measured data and timestamp	1254 bytes	About 0.6 ms/0.3 ms
Device Information Output Protocol	DIFOP	Outputting parameter configuration and status information	1248 bytes	1s (1 packet consecutively)
User Configuration Write Protocol	UCWP	Inputting user configured device parameters	1248 bytes	not fixed

5.1 MSOP Protocol

The data package outputs measured data such as the angle value, distance value, intensity value, and timestamp of the point cloud. The data of the package adopts Little-Endian mode.

The data package includes a 42-byte Ethernet header and a 1212-byte payload, with a total length of 1254 bytes. The payload consists of 1200 bytes of point cloud data (12 data blocks of 100 bytes) and 12 bytes of additional information (6 bytes of UTC, 4 bytes of Timestamp and 2 bytes of Factory).

5.1.1 Format

The CH32R lidar supports single and dual echo modes. Single echo mode measures the most recent echo value, and dual echo mode measures the most recent echo and the second recent echo value.

In the single echo mode, one echo data is measured after a single-point laser emission. A point cloud data package contains 12 data blocks, and each data block contains 1 set of 32-channel point cloud data measured in the packing order. Each data block returns only one azimuth angle. See the picture below:

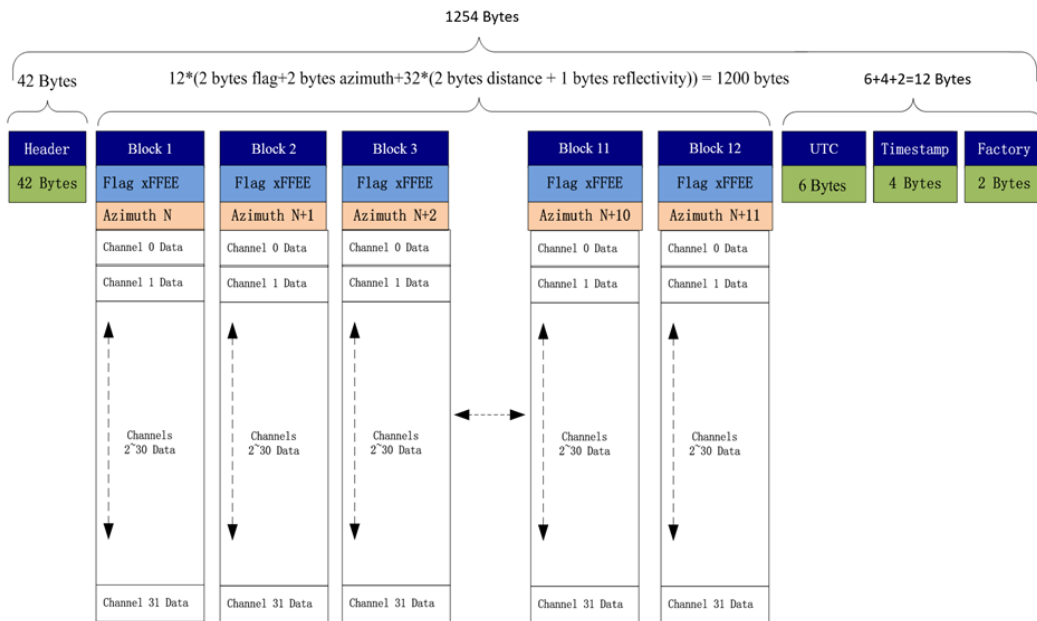

Figure 5.1 Data Format of the Single Echo Mode

When dual echo mode is adopted, two echo data is measured after a single-point laser emission. The data package contains 6 parity data block pairs, and every 2 data blocks contain 1 set of two echo values of 32 channels measured in the packing order. Block (1, 2) is the two echo data of the first 1 set of 32 point cloud data. The odd block is the first echo data, and the even block is the second echo data; Block (3, 4) is the two echo data of the next set of 32 point cloud data, ..., and so on. Only one azimuth angle is returned for each parity data block pair. See the picture below:

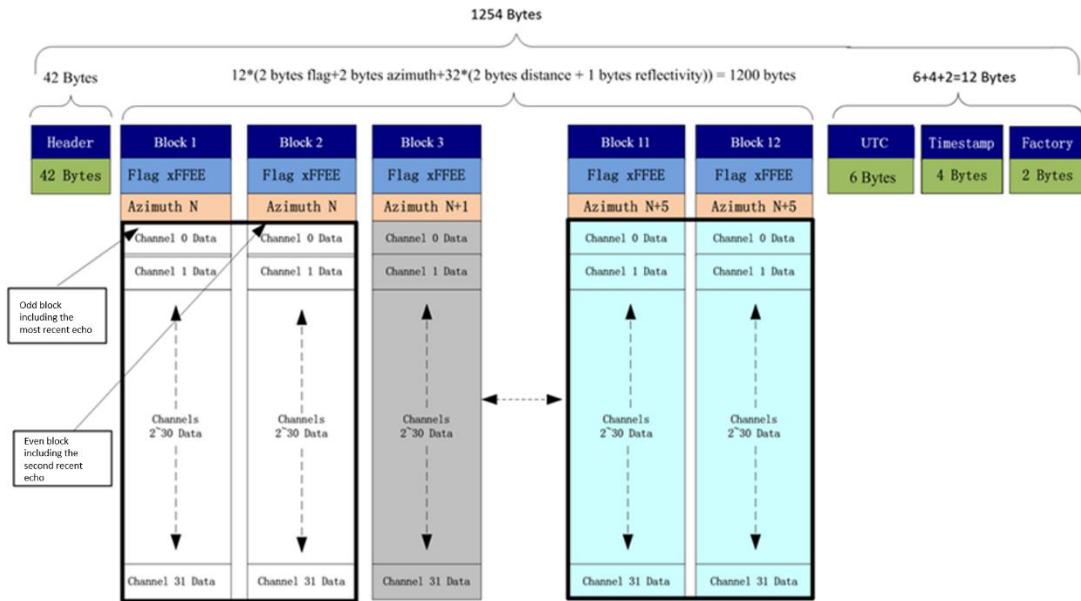

Figure 5.2 Data Format of the Dual Echo Mode

5.1.2 Data Package Parameter Description

Ethernet Header

The Ethernet header has a total of 42 bytes, as shown in the table below.

Ethernet Header: 42 bytes				
Name	S/N	Information	Offset	Length (byte)
Ethernet II MAC	0	Destination	0	6
	1	Source	6	6
Ethernet Packet Type	2	Type	12	2
Internet Protocol	3	Version, Header Length, Differentiated Services, Field, Total Length, Identification, Flags, Fragment Offset, Time to Live, Protocol, Header, Checksum, Source IP Address, Destination IP Address	14	20
UDP Port Number	4	Lidar Port (0x0941, represent 2369)	34	2
	5	Computer Port (0x0940, represent 2368)	36	2
UDP Length & Sum Check	6	Length (0x04BE, represent 1214 bytes)	38	2
	7	Sum Check	40	2

Data Block

The measured data has a total of 1200 bytes, which is composed of 12 data blocks, and each data block is 100 bytes in length.

A data block includes:

- 2 bytes 0xffee fixed value flag bit;
- 2 bytes Azimuth's relative horizontal angle information;
- 32-channel point cloud data (each channel 3 bytes). Each set of 32-channel data (UDP packet encapsulation sequence) corresponds to a 32-channel laser measurement data of the lidar at a certain launch time.

Note: The packing order of channel data increases in order. This order may be inconsistent with the vertical angle distribution order of the channel and the laser emission measurement time order of the channel, but there is a fixed one-to-one correspondence. (Refer to the Vertical Angle in Chapter 7 and the Channel Light-Emitting Time in Chapter 8)

Azimuth

The horizontal angle value—Azimuth represents the angle of the first channel 0 of the data block, which is a relative value and its unit is 0.01° . To calculate the absolute horizontal value, please refer to the description of section 7.2. The resolution of the horizontal angle value corresponds to 0.09° , 0.18° and 0.36° according to the motor speed 5 Hz, 10 Hz and 20 Hz.

Channel Data

Channel data is an unsigned integer, the 2 high bytes are distance, and the 1 low byte is intensity, as shown in the following table.

Channel N Data (3 bytes)		
Byte3	Byte2	Byte1
Distance		Intensity

The unit of distance is 0.4 cm. The echo intensity represents the energy reflection characteristics of the measured object, and the intensity value represents the intensity level of 0-255 different reflectors.

Related calculation example:

1) Horizontal angle value Azimuth: The obtained byte is in HEX: 0x12; 0x34, then the corresponding decimal DEC is: 18; 52

-> The actual angle obtained: $(52 * 256 + 18) * 0.01 = 133.30^\circ$;

2) Distance: The bytes obtained are in HEX: 0x56; 0x78, then the corresponding decimal DEC is: 86; 120

-> Actual obtained distance: $(120 * 256 + 86) * 0.004 = 123.224$ m;

3) Intensity: The obtained byte is in HEX: 0x90, then the corresponding decimal DEC is: 144

-> Actual obtained strength value 144;

4) Timestamp: The bytes obtained are in HEX: 0x78; 0x56; 0x34; 0x12; then the corresponding decimal DEC is: 120; 86; 52; 18

-> Timestamp = $(18 \cdot 2^{24} + 52 \cdot 2^{16} + 86 \cdot 2^8 + 120 \cdot 2^0) = 305419896 \text{ ns}$.

Additional Information

The additional information is 12 bytes in length, including 6 bytes of UTC, 4 bytes of Timestamp and 2 bytes of Factory.

Additional Information: 12 bytes			
Name		Length (byte)	Function
UTC		6	year/month/day/hour/minute/second, add 2000 to the value of year
Timestamp		4	Timestamp (ns), the least significant value in the sequence is stored first, at the lowest storage address while the most significant value is stored at the highest storage address.
Factory	Echo information	1	0x37 represents the strongest echo, 0x38 the last echo, 0x39 the dual echo
	Vendor information	1	0x10 represents C16 lidar, 0x5a represents CH32R lidar

1) When there is a GPS device inputting PPS signal to the lidar, the timestamp is generated with the PPS time as the cycle time, and the range of the timestamp is 0-999,999,999 (ns);

2) When there is an external synchronization device inputting PPS signal, the timestamp is generated with the external synchronization PPS time as the cycle time, and the range of the timestamp is 0-999,999,999 (ns);

3) When there is no synchronization device inputting PPS signal, the lidar generates timestamps with a period of 1 second. The range of the timestamp is 0-999,999,999 (ns).

5.2 DIFOP Protocol

The device package outputs read-only parameters and status information such as version number, Ethernet configuration, motor speed and operating status, and fault diagnosis. The data of the device package adopts Big-Endian mode.

The device package includes a 42-byte Ethernet header and a 1206-byte payload, with a length of 1248 bytes. The payload is composed of 8-byte frame header, 1196-byte data and 2-byte frame tail.

Figure 5.2 Data Format of the Device Package

Ethernet Header: 42 bytes				
Name	S/N	Information	Offset	Length (byte)
Ethernet II MAC	0	Destination	0	6
	1	Source	6	6
Ethernet Packet Type	2	Type	12	2
Internet Protocol	3	Version, Header Length, Differentiated Services, Field, Total Length, Identification, Flags, Fragment Offset, Time to Live, Protocol, Header, Checksum, Source IP Address, Destination IP Address	14	20
UDP Port Number	4	Lidar Port (0x0940, represent 2368)	34	2
	5	Computer Port (0x0941, represent 2369)	36	2
UDP Length & Sum Check	6	Length (0x04BE, represent 1214 bytes)	38	2
	7	Sum Check	40	2
Payload: 1206 bytes				
Name	S/N	Information	Offset	Length (byte)
Header	0	Device Package Identification Header	0	8
Data	1	Motor Speed	8	2
	2	Ethernet Configuration 1	10	22
	3	Ethernet Configuration 2	32	8
	4	Lidar Rotation / Stationary	40	2
	5	Reserved	42	2
	6	Clock Source Selection	44	2
	7	PPS Alignment Horizontal Angle Value	46	2
	8	Monitor PPS Alignment Angle Error	48	2
	9	Reserved	50	2
	10	UTC Time	52	6
	11	Latitude and Longitude	58	22
	12	APD Board Temperature	80	2
	13	LD Board Temperature	82	2
	14	APD High Voltage	84	2
	15	LD Emitting High Voltage	86	2
	16	No. 3 Plate Temperature	88	2
	17	No. 3 Plate Humidity	90	2
	18	GPS Status	92	1

	19	PPS Status	93	1
	20	High Temperature Suspension	94	2
	21	Cover Dirty Count	96	1
	22	Cover Dirty Alarm Message	97	1
	23	Cover Dirty Energy Value	98	2
	24	Threshold Adjustment Value	100	1
	25	Input Voltage Value	101	2
	26	Input Current Value	103	2
	27	Length of Work	105	4
	28	Reserved	109	1095
Tail	29	Frame Tail	1204	2

Header is the device packet identification header, which is fixed as 0xA5, 0xFF, 0x00, 0x5A, 0x11,0x11,0x55, 0x55, and the first 4 bytes can be used as the packet inspection sequence. Tail is fixed at 0x0F, 0xF0.

5.3 UCWP Protocol

The UCWP configures the lidar's Ethernet, PPS alignment angle, motor speed and other parameters, and the data of the configuration package adopts the Big-Endian mode.

The configuration packet includes a 42-byte Ethernet header and a 1206-byte payload, with a length of 1248 bytes. The payload is composed of 8-byte Header, 1196-byte Data, and 2-byte Tail.

Note: It is recommended to configure the lidar through the Windows Client. Please not package or configure the lidar parameters by yourself. The configurations take effect immediately.

Figure 5.3 Data Format of the Configuration Package

Ethernet Header: 42 bytes				
Name	S/N	Information	Offset	Length (byte)
Ethernet II MAC	0	Destination	0	6
	1	Source	6	6
Ethernet Packet Type	2	Type	12	2
Internet Protocol	3	Version, Header Length, Differentiated Services, Field, Total Length, Identification, Flags, Fragment Offset, Time to Live, Protocol, Header, Checksum, Source IP Address, Destination IP Address	14	20
UDP Port Number	4	Lidar Port (0x0941, represent 2369)	34	2
	5	Computer Port (0x0940, represent 2368)	36	2

UDP Length & Sum Check	6	Length (0x04BE, represent 1214 bytes)	38	2
	7	Sum Check	40	2
Payload: 1206 bytes				
Name	S/N	Information	Offset	Length (byte)
Header	0	Configuration Package Identification Header	0	8
Data	1	Motor Speed	8	2
	2	Ethernet Configuration 1	10	22
	3	Ethernet Configuration 2	32	8
	4	Lidar Rotation / Stationary	40	2
	5	Reserved	42	2
	6	Clock Source Selection	44	2
	7	PPS Alignment Horizontal Angle Value	46	2
	8	Reserved	48	1156
Tail	9	Frame Tail	1204	2

Header is the configuration packet identification header, which is fixed as 0xAA, 0x00, 0xFF, 0x11, 0x22, 0x22, 0xAA, 0xAA, and the first 4 bytes are used as the packet inspection sequence. The Tail of the frame is fixed at 0x0F, 0xF0.

5.3.1 Configuration Parameters and Status Description

Here below are the configuration parameters and status description of specific lidar information.

Motor Speed

Motor Speed (2 bytes)		
S/N	Byte1	Byte2
Function	Speed: 5Hz/10Hz/20Hz	

The motor rotates clockwise. Three speeds can be set: when it is set to 0x04B0, the speed is 1200 rpm, 20 Hz; when it is set to 0x0258, the speed is 600 rpm, 10 Hz; when it is set to 0x012C, the speed is 300 rpm, 5 Hz. Other setting data is not supported.

Ethernet Configuration

The length of the source IP address "IP_SRC" is 4 bytes and the length of the destination IP address "IP_DEST" is 4 bytes. Each lidar has a fixed MAC address "MAC_ADDR", which cannot be configured by users. Port1 is the UDP data port number and port2 is the UDP device port number. 4 bytes reserved.

Ethernet Configuration (22 bytes)								
S/N	Byte1	Byte2	Byte3	Byte4	Byte5	Byte6	Byte7	Byte8
Function	IP_SRC				IP_DEST			
S/N	Byte9	Byte10	Byte11	Byte12	Byte13	Byte14	Byte15	Byte16
Function	MAC_ADDR (Read Only)						Data Port: Port1	

S/N	Byte17	Byte18	Byte19	Byte20	Byte21	Byte22	
Function	Device Port: Port2		Reserved				

Lidar Rotation & Stationary

Lidar Rotation & Stationary (2 bytes)		
S/N	Byte1	Byte2
Function	0: Rotation; 1: Stationary	

0x0000 indicates that the lidar is rotating, and 0x0001 indicates that the lidar is stationary, and the default value of the lidar is rotating scan.

Clock Source Selection

Clock Source Selection (2 bytes)		
S/N	Byte1	Byte2
Function	0: GPS; 1: PTP (the unit of timestamp is ns); 0x0000 indicates GPS time service, 0x0001 indicates PTP time service	

PPS Alignment Horizontal Angle

When the lidar obtains the PPS signal input by the external device, it controls the lidar to scan to a specific horizontal angle at the moment. The configuration package sets the PPS alignment angle value, the unit of which is 0.01°. For example, if the alignment angle is 90°, the setting value should be 9000, and the hexadecimal number is 0x2328, corresponding to byte2 = 23h, byte1 = 28h.

PPS Alignment Angle Value (2 bytes)		
S/N	Byte1	Byte2
Function	Configure the PPS Alignment Horizontal Angle	

The device package outputs the PPS synchronization time. The unit of the alignment angle error, which is the difference between the actual scanning horizontal angle of the lidar and the set PPS alignment angle value, is 0.01°. "Valid is 0" indicates that the second pulse signal is valid. Angle_err[14:0] is the alignment angle error value, which is a signed integer with a range of -18000~18000, that is, between -180° and 180°.

PPS Alignment Angle Error (2 bytes Read only)		
S/N	Byte1	Byte2
Function	valid	angle_err[14:0]

5.3.2 Configuration Package Example

If parameters like motor speed, IP address, lidar device port number, NTP server address, PPS alignment angle value, lidar rotation/stationary, etc. need to be reset, according to the definition of the configuration package, the 1206-byte payload is set as follows:

Table 5.4 Configuration Package Example

Info	Content	Configuration	Start Position	Length (byte)
Header	-	0xAA,0x00,0xFF,0x11,0x22,0x22,0xAA,0xAA	0	8
Motor Speed	1200 rpm	0x04,0xB0	8	2
Lidar IP (IP_SRC)	192.168.1.105	0xC0,0xA8,0x01,0x69	10	4
Computer IP (IP_DEST)	192.168.1.225	0xC0,0xA8,0x01,0xE1	14	4
Device (MAC_ADDR)	XXXX (Read Only)	0xxxxx	18	6
Data Port (port1)	XXXX	0xxxxx	24	2
Device Port (port2)	8899	0x22,0xC3	26	2
NTP Server Address (Reserved)	192.168.1.106	0xC0,0xA8,0x01,0x6A	28	4
Gateway	192.168.1.1	0xC0,0xA8,0x01,0x01	32	4
Subnet Mask	255.255.255.0	0xFF,0xFF,0xFF,0x00	36	4
Lidar Rotation or Stationary	Rotation	0x00,0x00	40	2
Reserved			42	2
Clock Source Selection	PTP	0x00,0x01	44	2
PPS Alignment Angle Value	1.28°	0x00,0x80	46	2
Reserved	XXXX	0xxxxx	48	1156
Tail	Fixed Value	0x0F,0xF0	1204	2

Note: When encapsulating the configuration package, the entire package data must be written completely.

6. Time Synchronization

There are two ways to synchronize the lidar and external equipment: GPS synchronization and external PPS synchronization. If there is no external synchronization input, the lidar internally generates timing information. The absolute accurate time of the point cloud data is obtained by adding the 6-byte UTC (accurate to seconds) of the data packet and the 4-byte timestamp (accurate to nanoseconds).

6.1 GPS Synchronization

When GPS synchronization is employed, the lidar will start timing in nanoseconds after receiving the PPS second pulse, and the time value will be output as the timestamp of the data packet. The lidar extracts UTC information from the \$GPRMC of the GPS as the UTC time (accurate to the second) output of the device package.

There are two types of CH32R lidar GPS_REC interface level protocols, namely TTL level standard and RS232 level standard. The two protocols differ in two aspects, respectively:

TTL level pin definition:

Pin GPS_REC receives the standard serial port data of the TTL level output from GPS module;

Pin GPS_PPS receives the positive TTL synchronous pulse signal output by the GPS module;

RS232 pin definition:

Pin GPS_REC receives the standard serial data of the R232 level output from the GPS module;

Pin GPS_PPS receives the positive synchronization pulse signal output by the GPS module, and the level is required to be 3.0V~15.0V.

If the GPS you use outputs according to the RS232 serial port protocol, and the lidar receives data according to the TTL protocol, then a RS232 to TTL conversion module is needed.

The GPS equipment is time-synchronized to mark and calculate the precise emission and data measurement time of each laser. The precise time of the lidar point cloud can be matched with the pitch, roll, yaw, latitude, longitude and height of the GPS/inertial measurement system.

The default serial configuration baud rate of the GPS data output received by

the lidar is 9600, 8N1. The PPS high pulse width is required to be more than 1 ms.

The standard format of the GPRMC information is as follows:

\$GPRMC, <1>, <2>, <3>, <4>, <5>, <6>, <7>, <8>, <9>, <10>, <11>, <12> *hh

Table 6.1 The Standard Format of GPRMC Information

S/N	Name	Description/Format
1	UTC Time	hhmmss (hour/minute/second)
2	Positioning State	A=Effective Positioning, V=Invalid Positioning
3	Latitude	ddmm.mmmm (degree/minute)
4	Latitude Hemisphere	N (Northern Hemisphere) or S (Southern Hemisphere)
5	Longitude	dddmm.mmmm (degree/minute)
6	Longitude Hemisphere	E (East Longitude) or W (West Longitude)
7	Ground Speed	000.0~999.9 knot
8	Ground Direction	000.0~359.9 degree, take true north as the reference datum
9	UTC Date	ddmmyy (day/month/year)
10	Magnetic Declination	000.0~180.0 degree
11	Direction of Magnetic Declination	E (East) or W (West)
12	Mode Indication	Only NMEA0183 version 3.00 outputs, A= autonomic positioning, D= difference, E=estimation, N=invalid data

The CH32R lidar is compatible with GPS interfaces of multiple data formats. The GPRMC data format only needs to meet the following two requirements: the data after the first comma separator is hour, minute and second information; the data after the ninth comma separator is date information. The following two formats can be used normally:

1) \$GPRMC, 072242, A, 3027.3680, N, 11423.6975, E, 000.0, 316.7, 160617, 004.1, W*67;

2) \$GPRMC, 065829.00, A, 3121.86377, N, 12114.68162, E, 0.027, , 160617, , , A*74.

6.2 External Synchronization

In external synchronization, the lidar receives the PPS signal input by other external devices and times it in nanoseconds, and the timing value is output as the timestamp of the data packet. At this time, there is no UTC reference. If UTC is required, it must be written in the configuration package, otherwise the UTC output information of the device package is invalid.

The PPS level of the external synchronization signal is 3.3 V ~ 5 V, and the lidar receives the rising edge trigger, and the PPS high pulse width is required to be more than 1 ms.

6.3 gPTP Synchronization

Generalized Precise Time Protocol (gPTP) is derived from Precise Time Protocol (PTP) and is used to synchronize the time of individual devices within a local area network with high precision.

This series of lidar supports gPTP timing synchronization. Before synchronizing the lidar via gPTP, the time source needs to be set to “PTP” in the lidar's point cloud display software.

The steps are as follows: open the point cloud display software, click on “parameter” to bring up the parameter modification window, change “Source Selection” to “PTP” as shown in the figure below.

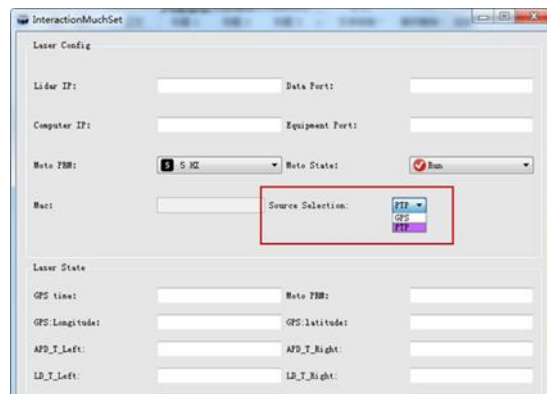

Note:

When PTP is selected as the clock source, the lidar no longer outputs GPS packets and the time unit changes to nanoseconds (ns). The Timestamp and Date & Time in the point cloud packets will be synchronized strictly according to the time signal provided by the PTP master clock.

If PTP has been selected as the time source and no PTP master clock is currently available, the lidar will start timing from the internal default start time (00:00:00 on 1 January 2000); if a PTP time source is provided and then interrupted, the lidar will continue timing from the time of the interruption.

6.4 Lidar Internal Timing

When there is no GPS and other equipment to synchronize, the lidar uses 1 second (1*10⁹ ns) as the cycle, with nanosecond as the timing unit, and the

timing value is output as the timestamp of the data packet. At this time, there is no UTC time reference. If UTC time is required, it must be written through the configuration package, otherwise the UTC time output information of the device package will be invalid.

7. Angle and Coordinate Calculation

7.1 Vertical Angle

Each channel of the CH32R lidar corresponds to a fixed vertical angle, see the table below.

Table 7.1 CH32R Vertical Angle

UDP Packet Encapsulation Sequence (Channel)	Vertical Angle	UDP Packet Encapsulation Sequence (Channel)	Vertical Angle
0	2.487°	16	47.201°
1	5.596°	17	49.999°
2	8.591°	18	52.798°
3	11.494°	19	55.596°
4	14.324°	20	58.26°
5	17.096°	21	60.87°
6	19.824°	22	63.498°
7	22.513°	23	66.144°
8	25.174°	24	68.819°
9	27.811°	25	71.525°
10	30.429°	26	74.274°
11	33.191°	27	77.074°
12	36.008°	28	79.938°
13	38.808°	29	82.884°
14	41.603°	30	85.933°
15	44.404°	31	89.105°

By querying the above table, the vertical angle of the 32-channel data can be obtained. Please note that the sequence of laser emitting is corresponding to the channel number (from channel 0 to channel 31).

7.2 Horizontal Angle

The horizontal angle value of the data packet is a relative value. Because the transmitter of the CH32R lidar is composed of multiple columns, the calculation of the absolute horizontal angle of each point requires interpolation.

7.2.1 Horizontal Angle Calculation of Single Echo Mode

In a single-echo data packet, each data block has only one horizontal angle value, which represents the horizontal angle value corresponding to channel 0 of the earliest transmission measurement of this data block. The angles corresponding to the other 31 channels need to be interpolated. Because the lidar rotates at a constant speed, the light-emitting time interval of each channel of the data block is the same, so after interpolating the two adjacent angle values (Azimuth N and

Azimuth (N+1)), and with the light-emitting time of each channel, the horizontal angle value corresponding to the remaining 31 laser shots of the block can be calculated.

The data block structure of the CH32R single echo packet is as follows:

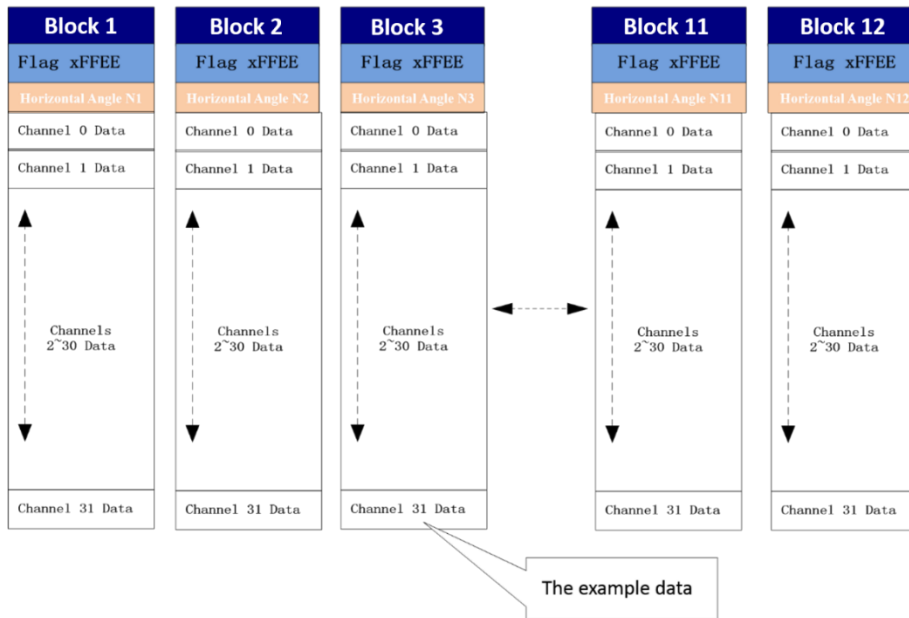

Figure 7.1 Single Echo Data Block Structure

Take Channel 31 data of Block 3 as an example:

- 1) The vertical angle of the Channel 31 can be obtained from Table 7.1.
- 2) The horizontal angle of the starting channel of Block 3 is N3 degrees, which is the horizontal angle of Channel 0. The horizontal angle of the next block is N4 degrees.
- 3) The horizontal angle of rotation between each channel of Block 3 is equally spaced $(N4-N3)/32$ degrees;
- 4) According to Table 8.1, the lighting time of Channel 31 ($T_0+(T*31)$) is the 31st time of Block 3, and its angular deflection relative to the lighting time of Channel 0 (T_0) is $(N4-N3) / 32*31$ degrees. Therefore, the horizontal angle of Channel 31 = $(N3+(N4-N3)/32*31)$ degrees;
- 5) Horizontal angle (absolute) = horizontal angle (relative) + angular deflection = $(Azimuth N + (Azimuth(N+1)- Azimuth N) / 32 * n)$ degrees. ("n" is the channel number: 0, 1, 2, ... 31).

7.2.2 Horizontal Angle Calculation of Dual Echo Mode

In the dual echo data packet, a single-point laser emission obtains two returned data. Every two data blocks contain two measured values of 32 channels of the

the same set, and each pair of parity data blocks returns only one azimuth angle (That is, the horizontal angles of odd-numbered blocks and even-numbered blocks are the same). The angle value provided by the N-th odd-numbered block and the (N+1)-th even-numbered block is the horizontal angle value corresponding to Channel 0 measured by the last laser emission, and the angle values corresponding to the other 31 channels need to be calculated by interpolation.

The data block structure of the CH32R lidar's dual-echo packet is as follows:

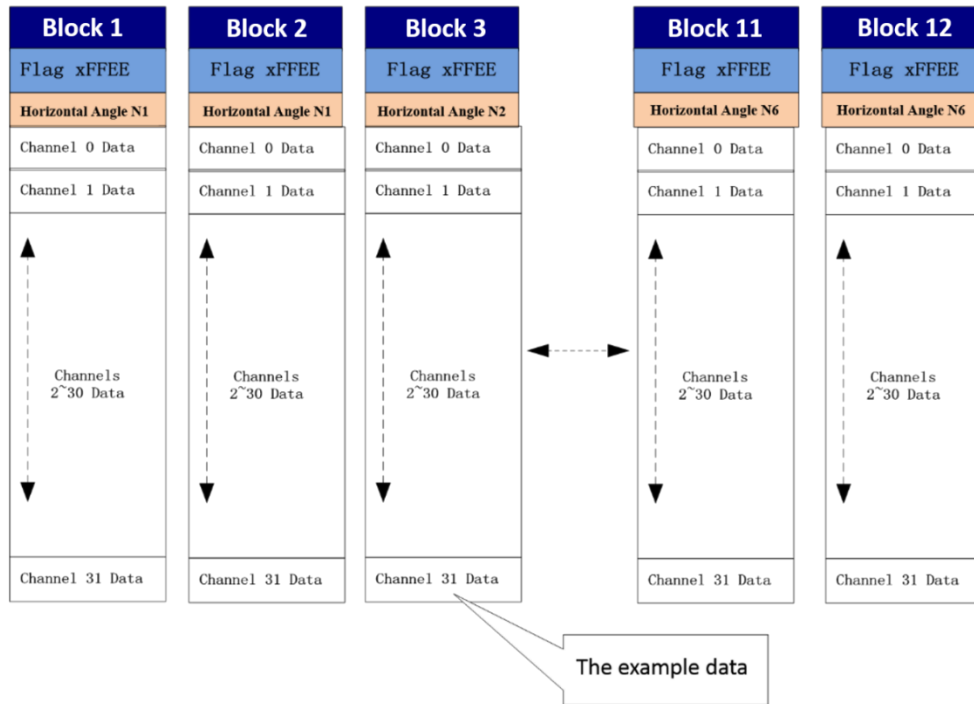

Figure 7.2 Dual Echo Data Block Structure

Take the Channel 31 data of Block 3 as an example:

- 1) From the picture above, it is clear that Channel 31 is at the end of each data block and is the last channel to emit light.
- 2) The horizontal angle of the starting channel of Block 3 is N2 degrees, which is the horizontal angle of Channel 0.
- 3) The horizontal angle of rotation between each channel of Block 3 is equally spaced $(N3-N2)/32$ degrees;
- 4) According to Table 8.1, the lighting time of Channel 31 ($T_0+(T*31)$) is the 31st time of Block 3, and its angular deflection relative to the lighting time of Channel 0 (T_0) is $(N3-N2) / 32*31$ degrees. Therefore, the horizontal angle of Channel 31 = $(N2+(N3-N2)/32*31)$ degrees;
- 5) Horizontal angle (absolute) = horizontal angle (relative) + angular deflection =

(Azimuth N + (Azimuth(N+1)-Azimuth N) / 32 * n) degrees. ("n" is the channel number: 0, 1, 2, ... 31).

6) Similarly, the calculation of the horizontal angle of each point of the dual echo mode is also consistent.

7.3 Cartesian Coordinate Representation

Obtain the vertical angle "Vertical Angle", the horizontal angle "Point Azimuth" and the distance parameter "Distance" of the corresponding point of the lidar and convert the angle and distance information in polar coordinates into x, y, and z coordinates in the right-hand Cartesian coordinate system. There are two conversion methods, as follows:

1) When the y direction is 0:

where r is the distance, α is the vertical angle, and θ is the horizontal rotation angle. x, y, z are polar coordinates projected onto the x, y, z axes.

$$\begin{aligned} x &= r \cos \alpha \sin \theta; \\ y &= r \cos \alpha \cos \theta; \\ z &= r \sin \alpha \end{aligned}$$

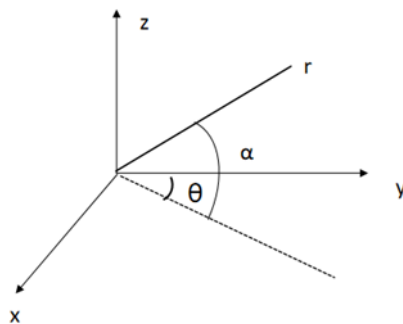

Figure 7.3 Coordinate Mapping (1)

2) When the x direction is 0:

where r is the distance, α is the vertical angle, θ is the horizontal rotation angle (the horizontal correction angle needs to be considered in the calculation), and x, y, and z are the polar coordinates projected onto the x, y, and z axes.

$$\begin{cases} x = r \cos \alpha \cos \theta; \\ y = -r \cos \alpha \sin \theta; \\ z = r \sin \alpha \end{cases}$$

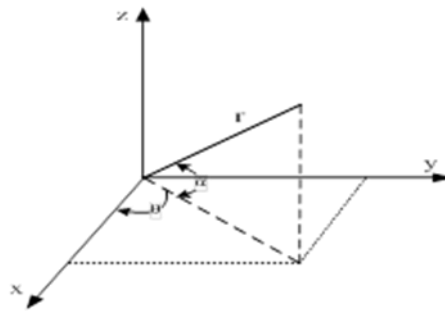

Figure 7.4 Coordinate Mapping (2)

7.4 Judgment of One Frame of Data

Assuming that the starting position of a frame is near 0 degrees, two adjacent angle values (Azimuth N and Azimuth (N+1)) can be used as judgment conditions. If the absolute value of (Azimuth (N+1) - Azimuth N) is greater than 180° , it is determined that the data of the Azimuth N block has reached the end of one frame (some points of this block, up to 31, may be the data of the next frame). The data of the Azimuth (N+1) block is collected as the data of the next frame.

8. Accurate Time Calculation

To accurately calculate the time of the point cloud data, it is necessary to obtain the timestamp of the data packet and the UTC of the device package output by the lidar. The timestamp and UTC time come from the same synchronization source, such as a GPS or PTP server.

The light-emitting time interval of each channel of CH32R lidar is 1562.5 ns. The data packet has 12 data blocks, and one data block contains 32-channel data. The measurement time interval of the data block is $1562.5 \text{ ns} * 32 = 50,000 \text{ ns}$.

A data packet has a total of $32 * 12 = 384$ channel data, and the packet packing time is about $50,000 \text{ ns} * 12 = 0.6 \text{ ms}$, and the data rate is $1 \text{ s} / 0.6 \text{ ms} = 1694.9$ data packets/sec. The data rate of dual echo mode doubles.

8.1 Calculation of Data Packet End Time

The timestamp in the data packet is a relative time in nanosecond, which is defined as the packing time of the laser measurement data of the last channel in the data packet (packet end time), and its duration is less than 1 second. Therefore, to calculate the absolute end time of the data packet, it is necessary to obtain the 6-byte UTC time (more than 1 second) and 4-byte nanosecond timestamp from the data packet. The addition of the two will be the exact time when the data packet ends.

8.2 Accurate Time Calculation of Channel Data

To obtain the accurate time of the end of the data packet, knowing that each of the 12 data blocks contains 32-channel light-emitting moments and the light-emitting time interval of each channel, the accurate measurement time of each channel data can be calculated.

8.2.1 End Time of Data Block

Each data block of the CH32R lidar contains 32-channel measurement data. Therefore, the end time interval of each data block (single echo mode) or each parity block pair (dual echo mode) is 50,000 ns. Assuming that the absolute time of the end of the data packet is $T_{\text{Packet_end}}$, the steps for calculating the end time of the data block $T_{\text{Block_end}}(N)$ are as follows:

Single Echo Mode

The data packet contains 12 data blocks. In single echo mode, each data block includes the measurement data of 32 laser channels. The end time of each data

block means that the 32 channels all end emitting light. The end time of each data block is calculated as follows:

$$T_{\text{Block_end}}(N) = (T_{\text{Packet_end}} - 50,000 \text{ ns} * (12-N)) \quad (N = 1,2, \dots, 12)$$

Here $T_{\text{Block_end}}(N)$ represents the end time of the N-th data block.

Dual Echo Mode

The data packet contains 12 data blocks. In the dual echo mode, Block (1,2) corresponds to 2 echo measurement data of 32 laser channels. Therefore, the end time of the two blocks is the same, and the light-emitting time of the laser corresponding to the same channel in the block is the same. Block (3,4), ..., Block (11,12) are the same. The end time of each block is calculated as follows:

$$T_{\text{Block_end}}(2N) = T_{\text{Block_end}}(2N-1) = (T_{\text{Packet_end}} - 50,000 \text{ ns} * (6-N)) \quad (N = 1,2, \dots, 6)$$

8.2.2 Calculate the Accurate Time of Channel Data

The light-emitting time interval of each channel of the CH32R lidar is fixed as: $T=50,000 \text{ ns} / 32=1562.5 \text{ ns}$. The light-emitting time has a fixed correspondence with the encapsulation order of UDP packets. Assuming that the light-emitting time of Channel 0 is T_0 , the corresponding 32-channel light-emitting time is shown in the following table:

Table 8.1 CH32R Lidar Channel Light-Emitting Time

UDP Packet Encapsulation Sequence	Light-Emitting Time	UDP Packet Encapsulation Sequence	Light-Emitting Time
Channel 0	T_0	Channel 16	$T_0+(T*16)$
Channel 1	$T_0+(T*1)$	Channel 17	$T_0+(T*17)$
Channel 2	$T_0+(T*2)$	Channel 18	$T_0+(T*18)$
Channel 3	$T_0+(T*3)$	Channel 19	$T_0+(T*19)$
Channel 4	$T_0+(T*4)$	Channel 20	$T_0+(T*20)$
Channel 5	$T_0+(T*5)$	Channel 21	$T_0+(T*21)$
Channel 6	$T_0+(T*6)$	Channel 22	$T_0+(T*22)$
Channel 7	$T_0+(T*7)$	Channel 23	$T_0+(T*23)$
Channel 8	$T_0+(T*8)$	Channel 24	$T_0+(T*24)$
Channel 9	$T_0+(T*9)$	Channel 25	$T_0+(T*25)$
Channel 10	$T_0+(T*10)$	Channel 26	$T_0+(T*26)$
Channel 11	$T_0+(T*11)$	Channel 27	$T_0+(T*27)$
Channel 12	$T_0+(T*12)$	Channel 28	$T_0+(T*28)$
Channel 13	$T_0+(T*13)$	Channel 29	$T_0+(T*29)$
Channel 14	$T_0+(T*14)$	Channel 30	$T_0+(T*30)$
Channel 15	$T_0+(T*15)$	Channel 31	$T_0+(T*31)$

After the end time of each data block is obtained, the precise measurement time of the point cloud data of each channel in the data block can be calculated according to the corresponding relationship between the channel data packing sequence and the light-emitting time in the above table.

Take the calculation of the data time T_{B3C3} of Channel 3 of Block 3 in single return mode as an example:

1) Obtain the UTC time T_{UTC} (converting to timestamp) and the nanosecond timestamp $T_{Timestamp}$ from the data packet, and the end time of the data packet $T_{Packet_end} = T_{Timestamp} + T_{UTC}$;

2) The end time of Block 3 $T_{Block_end}(3) = (T_{Packet_end} - 50,000 \text{ ns} * (12-3)) = (T_{Packet_end} - 450,000) \text{ ns} = (T_{Timestamp} + T_{UTC} - 450,000) \text{ ns}$, which is also the Channel 31 time of Block 3.

3) To calculate the Channel 3 time of Block 3, by consulting the table 8.1 above, the difference between the light-emitting time of Channel 3 ($T_0 + (T * 3)$) and the light-emitting time of Channel 31 ($T_0 + (T * 31)$) is $T * (31-3) = 28$ laser-emitting period. Therefore, the accurate time of this channel data $T_{B3C3} = (T_{Block_end}(3) - 28 * T) \text{ ns} = ((T_{Timestamp} + T_{UTC} - 450,000) - 28 * 1562.5) \text{ ns}$.

Take the calculation of the data time T_{B3C3} of Channel 3 of Block 3 in the dual echo mode as an example:

1) Obtain the UTC time T_{UTC} (converting to timestamp) and the nanosecond timestamp $T_{Timestamp}$ from the data packet, and the end time of the data packet $T_{Packet_end} = T_{Timestamp} + T_{UTC}$;

2) The end time of Block 3 $T_{Block_end}(3) = (T_{Packet_end} - 50,000 \text{ ns} * (6-2)) = (T_{Packet_end} - 200,000) \text{ ns} = (T_{Timestamp} + T_{UTC} - 200,000) \text{ ns}$, which is also the Channel 31 time of Block 3.

3) To calculate the Channel 3 time of Block 3, by consulting the table 8.1 above, the difference between the light-emitting time of Channel 3 ($T_0 + (T * 3)$) and the light-emitting time of Channel 31 ($T_0 + (T * 31)$) is $T * (31-3) = 28$ laser-emitting period. Therefore, the accurate time of this channel data $T_{B3C3} = (T_{Block_end}(3) - 28 * T) \text{ ns} = ((T_{Timestamp} + T_{UTC} - 200,000) - 28 * 1562.5) \text{ ns}$.

Appendix A. Maintenance

Shipping Requirements

CH32R series lidars use the packaging materials specially customized by our company, which can resist certain vibration and impact. For long-distance transportation, special packaging materials must be used to avoid irreversible damage during transportation.

Installation

Use screws that meet the specifications to fix the lidar base, and make sure the base has good heat dissipation. Wear powder-free clean gloves during installation to avoid optical cover contamination and mechanical damage.

Storage Conditions

The storage temperature of CH32R series products is $-40^{\circ}\text{C} \sim 85^{\circ}\text{C}$. It is recommended to store the products in a ventilated and dry place where the temperature is $23 \pm 5^{\circ}\text{C}$, and the relative humidity is $30\% \sim 70\%$. Do not store in environments where humidity, pH, etc. exceed the protection level.

Dirt Treatment

If the mask is dirty during use, such as with fingerprints, muddy water, dry leaves or insect corpses, etc., the lidar's ranging effect will be directly affected. Please clean it according to the following steps:

Tools: PVC gloves, clean cloth, absolute ethanol (99%)

Environment: ventilated and dry, away from fire

(1) Put on PVC gloves and fix the lidar base with your fingers; if it is not stubborn stains, use a dust-free cloth or dry air to gently remove the stains;

(2) For stubborn stains, evenly spray the ethanol in the spray bottle on the location to be cleaned and wait for the stain to be dissolved. Then use a dustless cloth dipped in ethanol solvent, and gently wipe the mask. If the cloth is contaminated, please replace it in time. After cleaning the stain, use a new dustless cloth to remove any remaining liquid.

Appendix B. Power Supply Requirements

This lidar's power input range is 9 V~36 VDC. If other DC power supply is adopted, the recommended output voltage is 12 V, 19 V, 24 V or 32 VDC. The output ripple noise should be <100mV (Vp-p) and output voltage accuracy <5%. The output power should be ≥30 W, for the lidar requires a large instantaneous current to start, and a small starting current may cause its failure to start normally. When the temperature drops below zero, the motor will require greater input power within a certain period of time.

The higher the power supply voltage and the stronger the discharge capacity, the more severe the impact on the lidar. Before mounting the lidar, please contact our technical support personnel for power supply environment evaluation to avoid damage.

For DC power supply, it is recommended to use wires of between 18 AWG and 26 AWG. The calculation formula of the voltage drop ΔU is shown below:

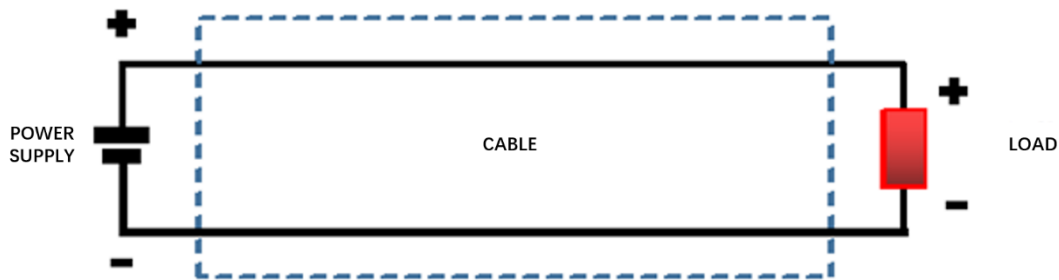

Equivalent Circuit:

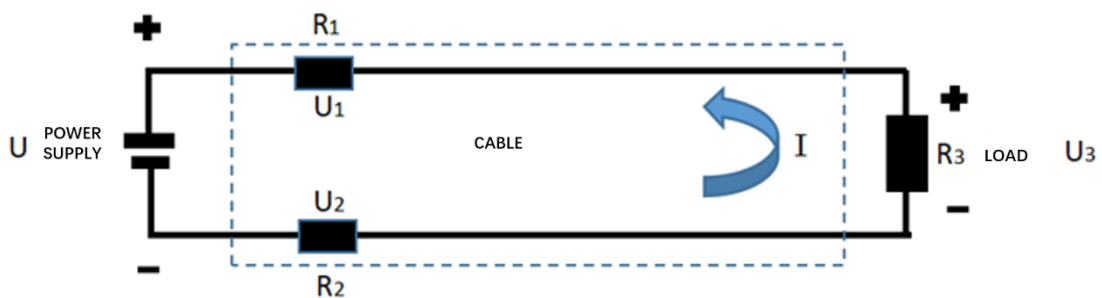

$$U = U_1 + U_2 + U_3$$

$$\text{Voltage Drop: } \Delta U = U_1 + U_2 = I * (R_1 + R_2) = 2 * IR_1 = I * \rho * L * 2 / S$$

It can be seen from the above formula that there are four factors that cause the voltage drop on the cable, namely: working current I, density ρ , length L, and conductor cross-sectional area S. When the lidar and wire are determined, then these four variables are all known quantities, and the voltage drop ΔU can be

calculated.

Since it is often impossible to carry out such detailed calculations on the construction site, we will give some suggestions based on our experience. For the use environment that requires long-distance power supply, if the length of the extension cable is within 5 meters, the power supply voltage can be 12VDC; 5~10m, no less than 19V; 10~50m, no less than 24V; more than 50 meters, it is recommended to supply power nearby with a 220VAC adapter to convert the power to 12VDC. This information is based on experience and is for reference only.

Revision History

Rev.	Release Date	Revised Content	Issued/Revised By
V4.0.0	2022-10-27	Initial Version	LS1286
V4.0.1	2022-12-05	Model and electrical parameters modified	LS1286
V4.0.2	2022-12-21	Wire definition of Adapter Cable updated; 6.3 gPTP Synchronization added; lidar internal timing modified	LS1286
V4.0.3	2023-02-08	Detection range updated	LS1286
V4.0.4	2023-02-27	Specifications updated	LS1286
V4.0.5	2023-05-06	Additional Information modified	LS1286
V4.0.6	2023-08-07	Specification updated	LS1499

*This product information is subject to change without notice.

Copyright ©2023 LeiShen Intelligent System Co., Ltd. All rights reserved.



**Make Safer Driving
Smarter Machine
and Better Life !**



Official Website: <https://www.lslidar.com>



Sales: sales@lslidar.com

After-Sales: support@lslidar.com